

EASTER SUNDAY SERVICES

(See page 4)

The TIMES JOURNAL

P. O. Box 2008,

Delivered to over 14,000 families

Parkland 44, Wash.

Thursday, April 11, 1963

Vol. 18, No. 32

Le. 7-0223

BULK RATE
U. S. Postage Paid
Parkland Branch
Tacoma, Wash.
Permit No. 9P

Rural Route
Occupant or Boxholder
Postmaster: If unable
to deliver, return post-
age is guaranteed on
addressed papers.

Winner Gets Keys



CAR WINNER—O. W. Carlson, head of the Summit Trading Company, here hands the keys to her new car to Mrs. Brenda Bee, who won the car at the contest held by the store, which ended Monday evening. —Times Journal Photo

Dates Set For 1963 Parkland Round - Up; Queen Contest On

Reverend Cooper To Preach Bethel Sunrise Service

Easter Sunrise Services to be held at the Bethel High School under the direction of Rev. Dan Cooper of Elk Plain have been changed from 6 until 6:30 a.m. Breakfast will be served immediately following the services, under the chairmanship of Mrs. Irma Antonie.

Bethel Booster board will be held April 15, 1963 at the high school. The next meeting will be April 29, at 8 p.m. and everyone is invited to come and share the fun. Hostesses for the evening will be the ladies from Clover Creek.

Election of officers will be one of the main points of business for the evening. Thanks is extended to Earl Platt and Mac Stephenson for the design and organization of our Bethel Daffodil float which took first place in its division. "Moments of Jazz" was the theme. Many thanks to all who helped in any way on the float.

More help is needed on the grandstands to complete the block work.

Kathy Polly Named Bethel Tolo Queen

Kathy Polly was crowned queen of the recent Bethel High School sophomore tolo dance and Phil McNiven was named as the king.

Other royalty for the successful affair were: Pam Kerns, Joy Morris, Carol Martinson and Sandy Lewis, Rick Carlson, Joe Knowles, Cody Miller, and Bob Atterstead.

Am. Legion Post To Sell Rummage

American Legion Post Unit No. 228 will be holding their annual rummage sale May 6-7 at 1706 Broadway, Tacoma. Helen Jensen will be sorting and pressing clothing in her home on April 17th. Please get your rummage together for this event.

Nomination of officers will be held at our next meeting, April 11th. Frank Berry is trying to make arrangements for the post and auxiliary to entertain the boys state advisors at dinner during this eventful week. Arrangements are being made for memorial services to be held for deceased veterans at the Parkland Grade School May 30th.

Collins Grange Plans Special Easter Meeting

Collins Grange will meet Thursday night, April 11 at 8 p.m. A special Easter program is being planned. Anyone with handicraft or hobby work is invited to bring it for display at the meeting. Jewel Balmer will be in charge of the social hour, assisted by Gertrude Ellison. All Grange members are urged to attend.

Parkland Round-Up Queen aspirants are invited to enter the 1963 contest, which opened this week. Entries must be filed by May 11. To get into the finals, girls must have sold at least 100 Round-Up buttons, and the girl who sells the most will receive a trophy, according to Betty Anderson, 9813 Pacific Ave., or The Times Journal, P. O. Box 2008, Parkland, Wash. Groups and organizations interested in entering the Round-Up parade are urged to file their entries with Larry Armstrong as soon as possible. Further announcements this week regarding Round-Up activities note that the Parkland Regatta is scheduled for June 2 on Spanaway Lake. More details on that event will be forthcoming later.

land Business Club will provide sponsors for girls unable to locate their own. An entry blank is provided in this issue for the convenience of contestants. It may be filled out and mailed either to Betty Anderson, 9813 Pacific Ave., or The Times Journal, P. O. Box 2008, Parkland, Wash. Groups and organizations interested in entering the Round-Up parade are urged to file their entries with Larry Armstrong as soon as possible. Further announcements this week regarding Round-Up activities note that the Parkland Regatta is scheduled for June 2 on Spanaway Lake. More details on that event will be forthcoming later.

Honor Troop 79 Scout



MOTHER'S PRIDE—A beaming Mrs. Lindell Schrawyer gets "pinned" by her son, Lewis, during a Court of Honor of Boy Scout Troop 79 at Clover Creek Grange Hall on April 2nd. Lewis is presenting his mother with a small replica of a star, emblematic of the Star Rank he has just achieved. His dad, left, looks on, with Martin Berger and Ben Wade, Scoutmaster, seated. (See also page 2 for more on Court of Honor.) —Photo by Dugan

Awarded Saturday

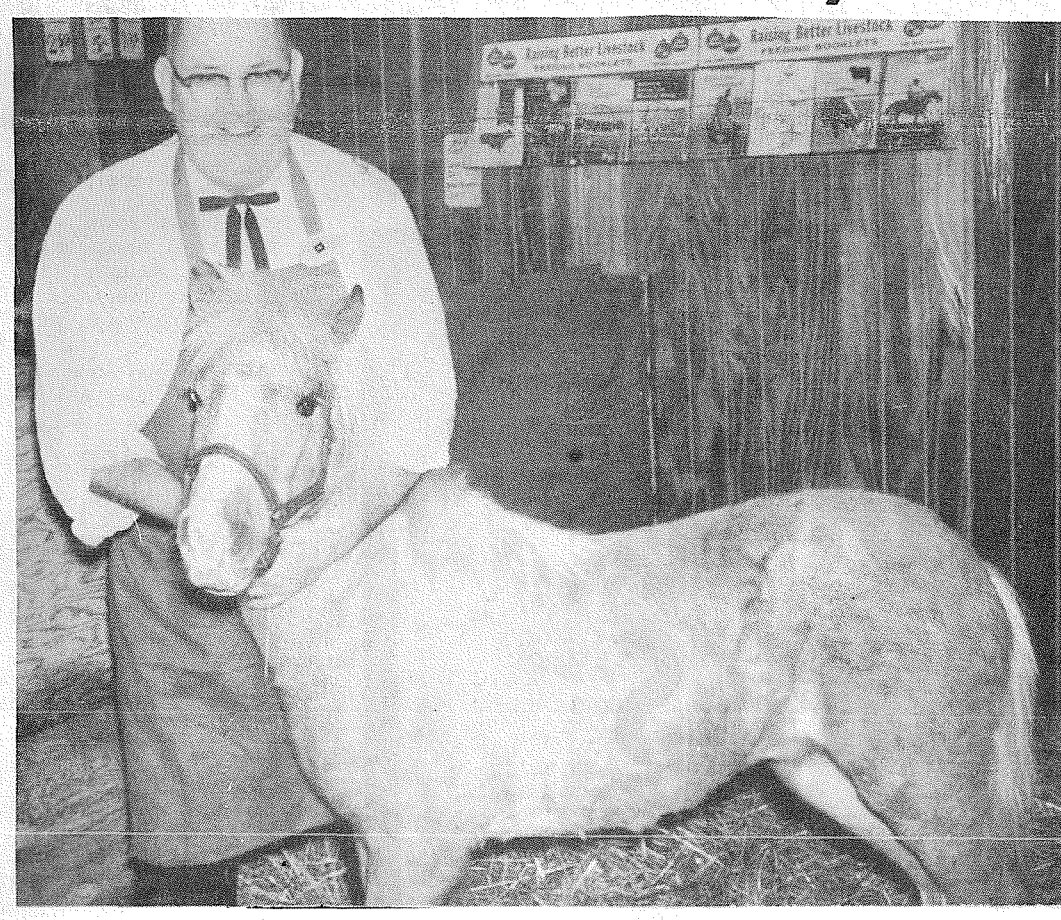

PONY PRIZE—Cy Payne, owner of the Farm Boys market, proudly shows off the Shetland Pony which his store awarded to Mrs. Helen Carlson last Saturday. The pony is registered. —Times Journal Photo

Nursery School Plans Election At Gonyea Park

Nomination and election of officers is slated for the Parkland Cooperative Nursery School at its meeting on April 18 at 8 p.m. at the Gonyea Park Fieldhouse. Mrs. Theodore Koopmans, coordinator for the Tacoma Council of Cooperative Nursery Schools, will speak on "Emotional Needs of Children." Hosts for the evening will be Mr. and Mrs. Neil Richardson, and Mr. and Mrs. James Hartley.

All parents interested in sending their children to the school next year are asked to register early. Registration can be made by calling Mrs. David Thorp, LE 7-5709 or Mrs. Charles Evans, LE 7-3384.

Brookdale PT-A Meets April 17

The Brookdale PTA meeting will be held Wednesday, April 17th at 8 p.m. in the school's multi-purpose room. The program will consist of Brookdale's 50-piece band which is made up of 4th, 5th and 6th grade students, under the direction of Robert Winters.



PETER GRUENSTEIN, renowned composer of "Misty", as he appears at the piano at the Three Monkeys Supper Club in Spanaway nightly.

Fill Out, Detach and Mail as Directed
TO: BETTY ANDERSON (ANDERSON LBR. CO.)
9813 Pacific Ave.
Parkland, Wash.
OR
THE TIMES JOURNAL
P. O. Box 2008
Parkland, Wash.
I, _____, living at _____, wish to enter the contest for Queen of the 1963 Parkland Round-Up and hereby agree to abide by the rules set down by the Parkland Round-Up Committee.
Date of Birth _____ Phone No. _____ Sponsoring Organization, if any _____

Creative Painters

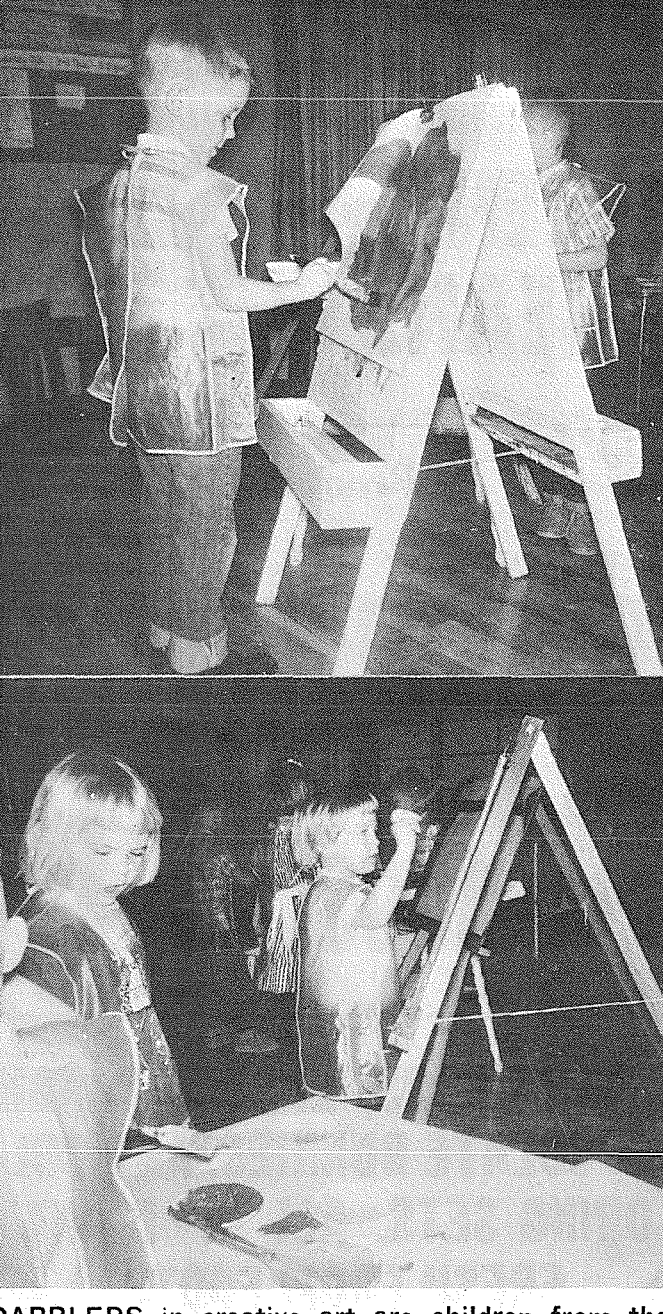

DABLERS in creative art are children from the Summit Cooperative Nursery, shown above having fun with paint and easel.

Lacamas-Bethel Combine Meeting

Lacamas-Bethel School held a joint meeting recent School District Organization. The Bethel Board set a Special Preliminary Budget Hearing for Tuesday, April 16th at 8:00 p.m. in the High School Library.

A general public information meeting will be held in Lacamas later in May to give full information on the operation plans. At its Annual Board Reorganization Meeting, Mr. R. T. Westerman was re-elected chairman. Mr. Francis Olson was re-appointed Clerk of the Board.

FP Key Club Toy Drive Aids Rainier

Franklin Pierce High School Key Club members are sponsoring a toy drive Friday, April 12, for the children at the Rainier School in Buckley.

Key Club members will collect toys, games and other useful items for the children, and will make repairs if necessary. Anyone wishing items picked up at their residence may call LE 7-4884, or toys may be left at Dillingham's Richfield Service Station, 12166 Pacific Ave.

Lady Lutes To Meet At Mortvedt Home

The last meeting for the Lady Lutes of PLU for this school year will be Tuesday, April 16th at 7:30 at the home of Dr. and Mrs. Robert Mortvedt.

The guest speaker for the evening will be Mrs. Harold Leraas, who will show slides and give a talk on the Holden Village. Officers for the coming year will also be elected. If you plan to attend please call Mrs. Leaf Lee, at LE 1-1002 or Mrs. Dennis Langston, LE 1-2722.

Riverside Grange Plans Breakfast

Riverside Valley Grange invites the public to their annual Easter Breakfast, Sunday, April 14th, at their Grange hall, located at the North approach of the Puyallup River Bridge at Clark's Creek, Puyallup. Serving from 6:30 a.m. to 12:00 p.m.

Queen Candidate



HOPEFUL—Marjan Kravic, candidate for the Queen of the Roy Rodeo, is shown with the saddle which will be awarded to the high point cowboy at the western event this year. The saddle, made by Severe Bros. of Pendleton, Oregon, is valued at \$250, and this year marks the first time an award of such nature has been offered at an amateur rodeo in this area. Miss Kravic, who is sponsored in her queenly bid by the Roy Pioneer Rodeo Association, reminds folks that this year's rodeo dates are Sunday, June 2nd and Sunday and Labor Day, Sept. 1st and 2nd. —Photo by Dugan

Royal Rangers Induct 20

Twenty boys have become charter members of Royal Rangers, the new boys program of the Spanaway Assembly of God, 166th and Pacific Avenue, according to the Rev. Ernest L. Friend, pastor of the church.

Recently launched by the Assemblies of God Men's Fellowship Department, the scouting type program has been organized to challenge boys in Bible instruction, Christian service, and the basic beliefs of the organization through interesting activities.

"Ready" is the motto for the Royal Rangers. First Aid, physical fitness, games, and projects will be studies in addition to cooking, campcraft, and nature studies.

The local Outpost is supervised by an Outpost Council — Marion Moe, 705 South Lafayette St., Parkland; John Allison, 2601 East 112th, Tacoma; and Leonard Smallwood, Rt. 1, Box 328-C, Spanaway. Mr. Marion Moe is Outpost Commander.

The Royal Rangers is divided into three age groups — Pioneers, ages 9-11; Trailblazers, 12-14; and Air-Sea Rangers, 15-17. The program is set up with achievement standards which the boys must earn. The raw recruit may advance through four ranks to attain a master rating.

Clarence Johnson, Rt. 1, Box 229-A, Spanaway, is Commander of the Pioneers; Don Johnson, Rt. 1, Box 484, Spanaway, is Lt. Com-

Noted Pianist At Spanaway Supper Club

Live jazz music came to Spanaway this past week with non less renowned person than pianist Peter Gruenstein of Holland, who formerly taught music at the Holland University of Art in that country.

Gruenstein, now making his home in Parkland, is the father of five lovely children and has come to love the country to the extent that he plans to make his home in the area indefinitely.

His background in music goes back almost his full 37 years, as he started playing piano at an early age. He is the undisputed master of the piano, organ, vibes, accordion and medieval European harp. He has played in such places as the Tuschinkie in Amsterdam and for such persons of nobility as Prince Bernard of the Netherlands, and is a graduate of the University of Art and Music in Amsterdam.

One of his closest friends,

mander, Kenneth Wood, 416 South 133rd St., Tacoma, is Commander of the Trailblazers, and Leo Crippen, Rt. 1, Box 1193 Bowers Road, Spanaway, and Larry Johnson, Rt. 1, Box 229-A, Spanaway are Lt. Commanders. Herschel Martin, 8620 East Taylor, Tacoma, is Commander of the Sea-Air Rangers, and Richard Funk, 10419 Golden Given, Tacoma, is Lt. Commander.

Uniforms of khaki shirts and trousers will use different colored neckties, to distinguish the various age groups in the program.

A full color emblem will appear on the left sleeve and the division name will be over the right shirt pocket. Optional clothing available to boys include imprinted T-shirts, sweatershirts, and jackets.

The boys meet on Tuesdays, 7:00 p.m. each week in the Spanaway Assembly of God annex.

Dennis Day, classes him as one of the greatest "keys" of all time.

Gruenstein, composer of "MISTY", a song sold on records by the millions, has two or three more almost completed. He will be appearing nightly at the Three Monkeys Supper Club in Spanaway and plans to continue his song writing during his spare time.

His war record is outstanding in the fact that he served the Allied underground for the full period of strife and still lived to witness VJ day. His duties were to listen to the free radios, transcribe what he had heard, run off mimeograph copies of this information and clandestinely distribute them throughout his native land.

You'll find Gruenstein an extremely likeable man with a repertoire ranging from progressive to classical music. Undoubtedly music lovers of this area will proclaim him as has been done throughout the world.

Spanaway Home League Events

Spanaway Home League will have United Home League at the Salvation Army Hall in Tacoma on Wednesday, April 10, preceded by Special Easter Service in the Chapel at 11 a.m.

There will be special music, and the guest speaker will be the Reverend Irvin McKinney from St. Luke's Episcopal Church.

Olympia and Bremerton Home Leagues will be the guests on this occasion.

Spanaway Home League will meet at the American Legion Hall in Spanaway on April 11 at 11 a.m. to make preparations for a visit to McGee's Guest House at 1 p.m. the same day. All those attending are asked to bring cookies and a sandwich.

FRIENDLY SERVICE SINCE 1908

Now With a 100 Car Free Parking Lot right next door.

PIPER FUNERAL HOME

PHONE Greenfield 2-3353 · 5436 SO. PUGET SOUND

Sales P-TA To Talk On Youth Fitness

The James Sales P-TA will meet on April 16th at 7:30 p.m. The flag will be presented by cub scouts of den 4, under the leadership of den mother Mrs. Louis Irvin.

The program for the evening will consist of a physical education demonstration by students of the physical education classes. Mr. Ellison, a 6th grade teacher will be in charge of the demonstration.

New charters for Cub Scout Pack 105 and the Boy Scout Troop 105 will be presented to President, Mrs. R. W. Switzer. Cubs of den 4 will present an Indian skit to demonstrate some of the cub scout activities. The Boy Scouts will have a display of their recent achievements.

A progress report will be made on the May 3rd family dinner and games night. Mrs. Donald Reed and Mrs. James Sloan are co-chairmen for this event.

The new officers elected to serve during the 1963-64 school year are as follows: President, Mrs. Louis Irvin; Vice-President, Mrs. Del Miller; Secretary, Mrs. Richard Simmons; Treasurer, Mr. Jim Sloan.

County Loops Plan Meeting

The Pierce County Recreation Department will hold a meeting Monday, April 15th at 7:30 p.m., Room 741, County-City Building for all County Connie Mack, Colt, Junior Boys, Valley, and County-City Baseball leagues.

On Tuesday evening, April 16th the managers and coaches of all County-wide girls and women leagues will get together at 7:30 p.m., Room 741 at the same location. These leagues include Senior Girls, Junior Girls, Filly, Lassie, Housewives, and Womens Open Softball League.

Plans for the coming campaign will be discussed, and it is hoped that all interested persons will attend the meeting of their choice so that rules and regulations for the coming season can be mapped out.

Plans call for all the above mentioned leagues to start play the first week in June. Any further information may be had by calling the Pierce County Recreation Department, PU 3-3311, Ext. 386.

Court Of Honor Cites Many

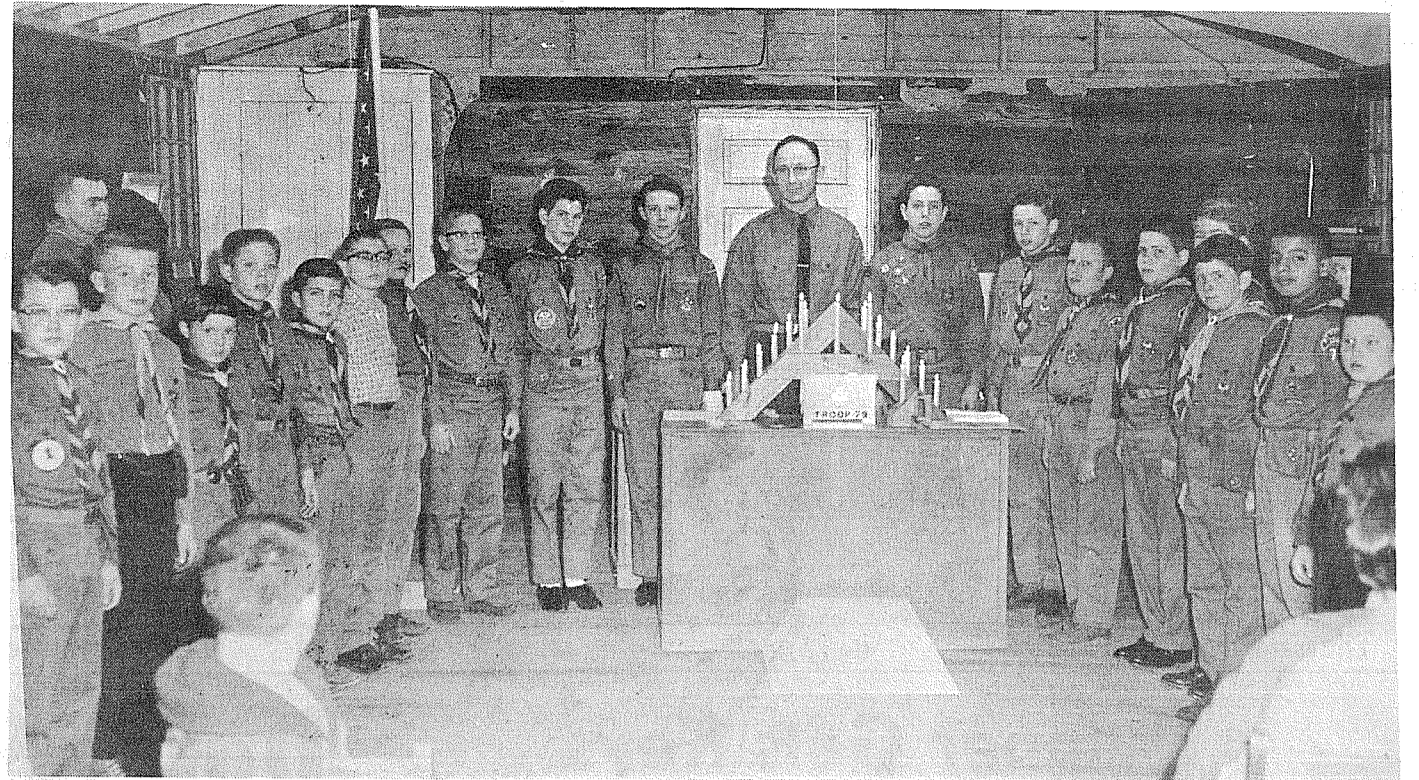

COURT OF HONOR—Boy Scout Troop 79 held a Court of Honor April 2nd, officially advancing several members to higher rank, and advancing Lewis Schrawyer to Star Rank. Posing for a portrait are the following: Gary Wade, Lonny Short, Chuck Hiller, Mark Leonard, Steve Loper, David Kirkman, Fred Kistenmacher, Kerry Barry, Steve Leonard,

Dave Berger, Ben Wade, Scoutmaster, Lewis Schrawyer, Steve Berger, Ronnie Orchard, Michael Matter, Michael Kalahan, Mike Schueller, Albert Alvarez Jr. and Stanley Farce. Ed. Tiel, Assistant Scoutmaster is in rear at left. (See photo on page one.) —Photo by Dugan

Schrawyer Lad Recieves Star Boy Scout Rank

Egg Hatching Wins Tots Attention

The children at Summit Cooperative Nursery are busy preparing Easter eggs for their annual Easter Egg Hunt to be held April 11th at the home of Mrs. Shadlow.

A timely visit to the Star Ranch Hatchery was made on April 4th where the youngsters observed the hatching of chickens.

Mrs. William Hoffman will preside over the Mother's Meeting April 16th at the home of Mrs. Duane Lobeda. Mrs. Robert Cox and Mrs. Perry King will be co-hostesses.

Applications are being taken by Mrs. Hoffman at TH 5-5353 and Mrs. Fred Haynes, TH 5-9164 for the new term. Children must be in the 3 to 5 age group.

Lewis Schrawyer, son of Mr. and Mrs. Lindell Schrawyer, of Rt. 2, Spanaway, received his Star Rank in Boy Scout Troop 79 at a Court of Honor at Clover Creek Grange Hall on April 2nd.

The Honor Court also marked the elevation of three Scouts to Tenderfoot rank, and six boys to second class and one to first class.

Lewis, who has been in the Scouts a little over two years, has also earned merit badges in Marksmanship, Music, Reading, First Aid, Safety, Swimming, Pioneering, Camping and Rowing. His Star Rank marked the first such honor bestowed on a boy in Troop 79 in Mt. Rainier Council.

Martin Berger, Liaison officer for the Troop, presented Lewis with his award, who, in turn, presented a miniature star to his mother.

Awards to the other boys were made by Ben Wade, Scout Master. Honored with Tenderfoot rank were Ronald Orchard, Chuck Hiller and Dave Kirkman.

Second Class scout rank was bestowed upon Steve Berger, Mike Kalahan, Fred Kistenmacher, Mark Leonard, Steve Leonard and Michael Matter.

Dave Berger was presented with his First Class rank.

Park Service Installs Ticket Vendors

Ticket-vending machines for collection of a service fee will be in operation this summer at 30 of the 850 campgrounds in the National Forests of the Pacific Northwest Region (Oregon and Washington).

The 30 sites include about 1,450 family camping units. Picnicking, boat-launching, and other day-use activities at these sites remain free of charge.

The U.S. Forest Service has furnished free recreation facilities at campgrounds and picnic sites for many years. But as facilities are improved and demands increase, it is probable that charges will be required for use of many of the developed sites, according to J. Herbert Stone, Regional Forester.

New facilities—roads, toilets, etc.—are being installed at campgrounds, including many of those which will carry the \$1.00 service charge this summer. Such construction and the job in installing ticket machines may affect the beginning dates for this year's charge program.



Avycc Blanchfield
Income Tax Service
Now At
17023 S. Park Ave.
Residence
LE 7-5795

VAUGHAN'S VALUES

Check Your Requirements For Home And Property Improvements

- More Living Space
- More Kitchen Space
- More Sleeping Space
- Ceiling Tile
- Fencing
- Storm Doors

Free Planning and Estimates
EASY MONTHLY PAYMENTS
VAUGHAN'S PACIFIC AVENUE LUMBER
Serving the Tacoma Area Since 1926
84th and Pacific Ave. GR 4-9515

JUST IN TIME FOR **EASTER**

For Her

TOILETRIES by Coty

SPRAY TOILET WATER \$3.50
In L'Origan, L'Aiment, Emeraude and Paris Scents.

RED ROSES GIFT SETS \$3.95
By Yardley

MAGNETIQUE SPRAY
Cologne \$2.50 - Body Powder \$2.50. Set \$5

For Men

GIFT SETS by OLD SPICE \$2.50
Shave Lotion \$1.25; Cologne \$1.25; Soap \$1

Full Stock Easter Baskets and Candy
McAULEY SUMMIT DRUG
5405 E. 112th Hrs. 9 to 9 week Days LE 7-0668

"You Do Save More at Your Farm Boy Store"

PRICES EFFECTIVE April 11-12-13

"We Reserve The Right To Limit"

the FARM BOYS

Hours: 9:00 'Til 9:00 - Sundays 9:00 'Til 7:00
E. 112th & CANYON ROAD

SHEPHERD PONY WINNER
Mrs. Helen Carlson 3518 E. 52nd

LOCKER BEEF WINNER
J. F. Daugherty 4923 E. Mt. Tacoma Dr.

GROCERY WINNER
Shirley Challender 3202 138th E.

CORN-SIDERABLE FUN FOR EVERYONE!

10,006 PRIZES

Kellogg's "Corny" Jingle CORNTEST

CORN FLAKES KELLOGG'S 12-Oz. Pkgs. **4/\$1**

Repeat Of A Sellout

GREEN BEANS SILCO-CUT 303 Tins **9¢**

White And Pink SILK

FACIAL TISSUES

6 400 COUNT **\$1**

In Les' Meat Dept.

Steak Sale!

FULL ROUND or RIB LB. **73¢**

GROUND BEEF 3 LB. **98¢**

Produce

RED - RIPE STRAWBERRIES Full Cup **29¢**

Fresh New Crop **ASPARAGUS** LB. **15¢**

EASTER CARDS, EASTER CANDIES CHOCOLATE BUNNIES, AND COLORING SETS. ALL GOOD AND FRESH FROM FOOTS.

Soap Sale

TIDE KING SIZE Includes 15¢ Off **98¢**

IVORY Personal 20 Bars **\$1**

FARM BOYS PINK LIQUID DETERGENT

20 OZ. **45¢** 32 OZ. **59¢**

Summit Girls Honored At Award Court

Miss Sue Johnson
LE 7-7150

March 27th, a Court of Awards was held at the Youth Center for the girls of Troop 93. The presentation was given by the Wildlife Patrol.

The following badges and awards were presented: Tenderfoot, Rondi Hansen. Second Class: Linda Daffer, Shelly Morris and Katherine Vickers. First Class: Martha Vickers.

Special awards were: Shelly Morris, Cook, Athlete, Skating, Animal, Good Grooming, Traveler and Cyclist. Linda Schmidt, Cook, Pam Tresch, Traveler, Horsewoman, Dog and Cat, Cyclist, Skating, Drawing and Painting, Dancer. Terri Larimore received badges for Child Care, Drawing and Painting, Wendy Ward, Adventurer, Backyard Camper, Cook, Sports, Athlete and Skating. Adrian Rayeski, Dancer, Speaker, Home-maker, Cook, Housekeeper and Mammal. Evelyn Kinton received her Reader awards. Carol Rayeski, Horsewoman, and Dancer. Marshelle Torbet, Rambler, Drawing and Painting, Swimming, Camp-craft, Child Care and Bird.

Susann McAllister received her World Pin and the One Year Pin went to Terri Larimore.

Entertainment for the evening was given by Evelyn Kinton who wrote and directed a skit. Those in the skit were Susan Dowie, Pam Tresch, Marcy Torbet, Shariene Wild and Adrian Rayeski.

For their badges, the girls must do special jobs for recognition. Adrian Rayeski gave a wonderful speech on Girl Scouting to receive her Speaker badge. The Rambler badge won by Marcy Torbet represented a constellation stage of the stars. For her child care badge, she also made a bib and presented it to Mike Tresch.

Virginia Shirley, Troop Assistant, has applied for a counselor's job at St. Albans for the summer vacation.

Easter Service Set
The Summit Methodist Church has planned several special programs for the observance of Easter. Easter Sunday, April 14th the Sunrise service will be held beginning at 8:00 a.m. in the McMillan's back yard, 10305 East Canyon Road. At 7:00 a.m. the men of the church will serve a special Easter breakfast in the Fellowship Hall of the church. Easter worship services will also be held at 9:45 and 11:00 a.m. where special music by both of the choirs is planned.

Teen's Adult Board Elects
The Adult Board of the Summit Teen Club met Monday evening, April 1, at the Youth Center. Those present were Mr. and Mrs. Pruitt, Mrs. Kirkpatrick, Mrs. Adams, Mrs. Robinson, Mrs. Reid, Mr. and Mrs. Johnson, Mrs. Herrington, Mrs. Wilde, Mrs. Torbet, Bill Rave and Mike Schultz.

Election of officers was held and the following parents were elected to the one year term of office. Chairman of the board is Mrs. Jane Adams; Vice-chairman is Mrs. Kirkpatrick; and Secretary is Mrs. Ruth Johnson.

The purpose of this board is to help the Teen Club with problems in their activities.

Car Wash
The M.Y.F. of the Summit Methodist Church is sponsoring a car wash to be held Saturday, April 13th at the Thriftway Store in Summit-View. The hours will be from 12:00 noon on and charge of \$1.00 is all that it will cost. Come out and support the youth of the church.

To become an able and successful man in any profession, three things are necessary, nature, study, and practice.

—H. W. Beecher

Complete Repair SERVICE

- Television
- Ranges
- Washers
- Dryers

RADIO DISPATCHED FOR FAST SERVICE.

SILER'S

TV and APPLIANCE
11230 Pacific Avenue
LEnox 7-8634

HAM IS HEAVENLY

Read Shop-Rite Ad
in Wed. News Tribune
For Additional Values

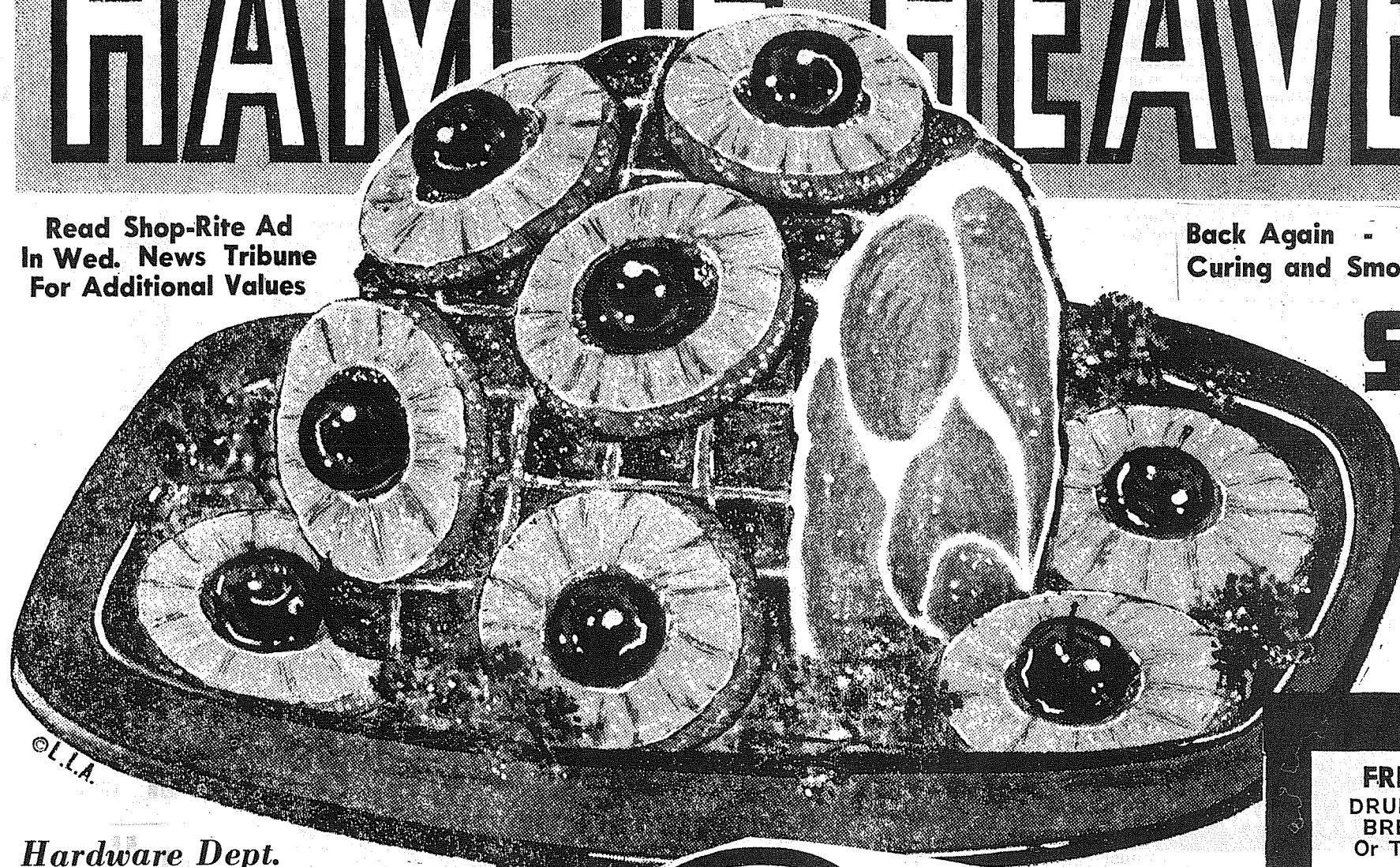

Back Again - Summit Trading's Famous
Curing and Smoking of Hams and Bacon!

SMOKED HAM 39
Federal's Hickory Smoked 5 - 6 Lb. Shank Portion. Lean, Trimmed. Lb.

BONELESS HAMS 79
Fully Cooked Hygrade "Fiesta" Or Bar-S "Holiday" Lb.

CANNED HAMS
SWIFT PREMIUM BONELESS
5-LB. TIN 3.69
HAM SLICES
Or ROASTS CENTER CUTS Lb. 79

WHOLE HAMS
Or FULL SHANK HALF Lb. 45

Hardware Dept.



JEEPERS! Look at the MONEY we SAVED on my NEW

Schwinn

SPRING BIKE SALE!

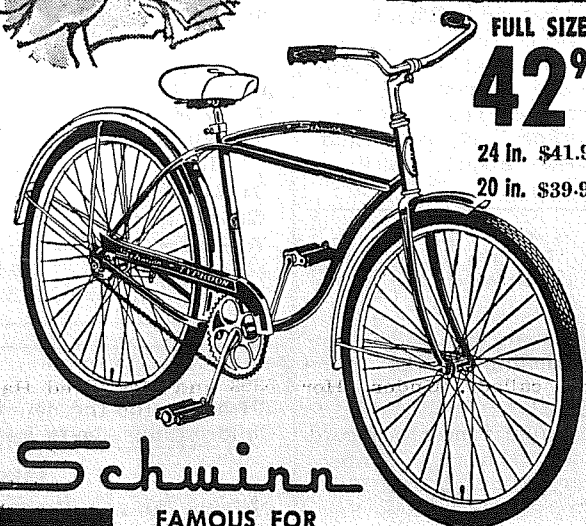

FULL SIZE

42⁹⁵

24 in. \$41.95

20 in. \$39.95

Schwinn

FAMOUS FOR FINE QUALITY!

Feature Packed TYPHOON

- Electro-forged twin-bar frame
- Cushioned two-tone saddle
- Built-in kickstand
- Schwinn approved coaster brake
- Schwinn tubular rims

Schwinn Quality saves you money

Schwinn Factory Trained Service

On Display

LATEST IN CAR-TOP BOATS

Glass And Aluminum

TROLLING MOTORS

Johnson 3&5½ H.P. Plus

Westport Type Fishing

Boats And Johnson

Motors



and nothing's more fun than oops... coloring Easter Eggs!

Shop Rite
FOOD CENTERS

We Have A Large Selection Of Easter Candy, Eggs & Dye

FRESH FRYER PARTS

DRUM STIX BREASTS Or THIGHS Lb. 59

WINGS Pound 29

BACKS And NECKS Pound 15

LINKS PURE PORK HENRY HOUSE Lb. 59

SAUSAGE ROPE STYLE FEDERAL Lb. 59

OYSTERS FRESH MED. SIZE 12-Oz. Jar 53

Wholesale Meats — Free Delivery
HALF OR WHOLE Lb. 49
HIND QUARTER Lb. 55
FORE QUARTER Lb. 45
HALF OF HOG Lb. 39
Cut and Double Wrapped. Quick Frozen

JELL-O EGGS

Delicious Fruit Flavors For Just A Nickel.

OUR EASTER SPECIAL PKG. 5

AA Med. Ranch Fresh DOZEN 39

ICE CREAM

Foremost Big Dip or Velva ½ GAL. 59

ASPARAGUS

Fancy No. 1 Fresh As A Daisy

LB. 17

POTATOES

Fancy New California Shaffers

LB. 5

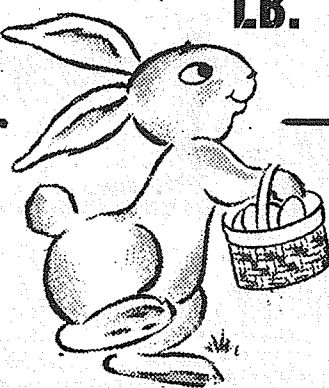

Chunk Light TUNA ½ Tins 4/\$1

Fast Friendly Service!

U.S. Post Office Here LE 7-5848

SUMMIT TRADING CENTER

Shop Rite
FOOD CENTERS

Large Selection Of Easter Lilies

Fresh and Artificial

CRISCO

WOW! SAVE AT SUMMIT TRADING!

3-LB. TIN

69

MAYONNAISE Kraft 49

HIC DRINKS 5 Flavors 46-OZ. TINS 4 \$1

ANGEL CAKE Hostess Fresh 3 FOR \$1

BAKERY DEPT.

FRENCH BREAD Large Loaf 19

HAMBURGER or WIENER BUNS 4 Pkgs. \$1

OVEN FRESH BREAD 4 Large Loafs \$1

Half the things that people fear of making the attempt, do not succeed in are through —James Northcote

GEHL SELF-UNLOADER

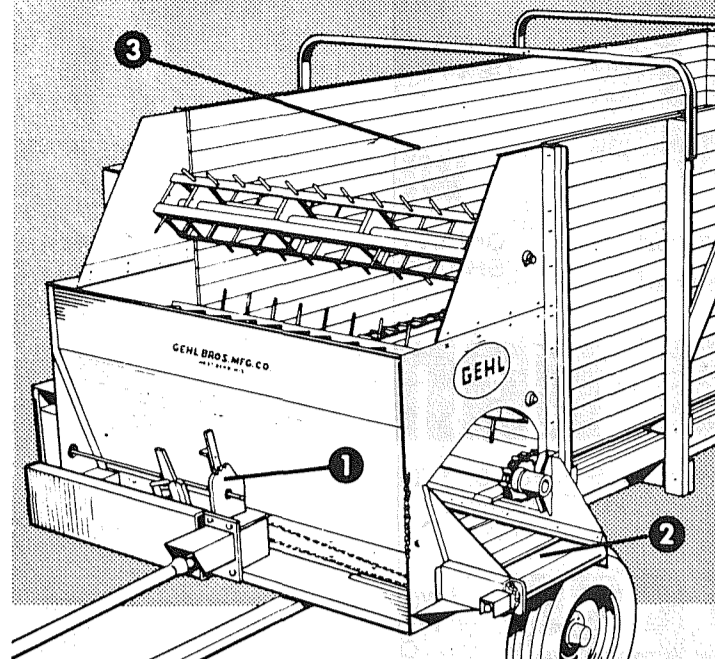

WITH FINGERTIP CONTROLS

1 Gehl clutch and speed controls are handy... at your fingertips. Cross conveyor runs when you start PTO. Beaters and box bed chains work together at a flip of the clutch. Change to any of three unloading speeds or neutral without using clutch.

2 Positive front-roller chain drive sends a high-speed flow of forage or grain from box to blower. No slipping of the wide, ribbed rubber cross conveyor... ton-a-minute unloading.

3 Gehl metal parts are of welded structural steel. Boxes are of fine-grain, specially treated, matched lumber. They're available with 2, 4 or 6-ft. sides. Standard length is 16 ft. Can be built shorter or longer to fit your needs.



STOP IN AND LOOK IT OVER
Wayne Buck Sales, Inc.
3701 Pacific Highway E. WA 2-8742
FIFE, WASH.

Foresters At Lacamas Seat Officers

Marjorie L. Smith, Rt. 1, Box 110, Roy, Wash., April 4th, the Evergreen Forestry and Rifle 4-H Club officers of Lacamas were installed into their new offices by Mrs. Stuart Kimball with guides Mrs. H. Kravik and Mrs. H. Trusler assisting at the Community Hall. Those being installed were Larry Smith, President; Rick James, vice president; Rita Dickey, Sec. Treas.; Linda Dove, reporter and John McDonald, sergeant-at-arms.

Rita Dickey and Timothy McIntyre played accordion solos and we sang "America The Beautiful", accompanied on the piano by Mr. Stuart Kimball.

Following the entertainment the president introduced their leaders, Mr. and Mrs. Fred Smith and Mr. and Mrs. Fritz of the American Legion Post No. 228 at Parkland. The meeting was then turned over to Mr. Fritz who presented the 4-H flag with the American flag and the 4-H stands and gavel. Mr. and Mrs. Smith are Post 228 members, too.

The meeting was adjourned.

LINCOLN PENNIES WANTED
1909-S-VDB \$50
1914-D \$30
1924-D \$8
1931-S \$25
LE 7-4745 After 6:00 p.m.

to a beautifully decorated 4-Leaf Clover cake and two small tree cakes which were done up by Mrs. Betty McDonald. Thank you for the wonderful work, Betty.

Thanks also go to Mrs. H. Kravik, Mrs. H. Trusler and Stuart Kimball and the American Legion for their work; Rita Dickey and Timothy McIntyre for the entertainment, Alice Armstrong of Parkland for doing the programs up, and Eleanor Trusler who served the cake, Mrs. Les Dickey, Mrs. Charlie Flowers and Mrs. F. L. Hartew who assisted in the kitchen.

Those attending were as follows: Walt Fritz, Post No. 228; Krafty Kapers 4-H Club Thrift; Mrs. Ken Singleton, Mrs. Phyllis Carson, Linda Carson, Judie Mattson, Gerri Singleton, Timm Singleton and Flora Shoemaker; Judy Talbot from Tonasket; Mrs. Mat Kimball and Stuart Kimball from Tacoma, Mrs. John McDonald and John McDonald Jr., Robert and Richard Allen from Graham; Mrs. Sam James, Mrs. H. Trusler, Mrs. H. Kravik, Mrs. F. L. Hartew, Mrs. Les Dickey, Mrs. Arthur McIntyre, Mrs. Lawrence Dove, Mrs. Charlie Flowers, Mr. and Mrs. Fred Smith, Elizabeth Trusler, Rosemary Smith, Cynthia Smith, Lovena and Danny Dove, Eleanor Trusler, Larry,

Jarry and Dennis Flowers, Linda and Larry Smith, Linda and Carolyn Dove, Bill Hartew, Rick James, Henry Trusler, Tim McIntyre, Rex Dickey and Rita Dickey and Allan Smith from Roy.

Lacamas Ladies
Lacamas Ladies Auxiliary will hold a card party at 1 p.m. in the Lacamas Community Hall on the Harts Lake Loop Road April 25th.

Recovering
We are glad to hear Chuck Flowers is so much better after much doctoring for an eye injury.

No Dance
Lacamas Community Club meet at the hall on April 2nd. It was decided not to have a dance this month. The curtains for the hall were discussed. There also was discussion on the Lacamas Fair. Meeting was adjourned to coffee and cake served by Mrs. Darlene Coots.

Deadline Revision
Your reported wishes to make a correction on last week's Fair announcement. The deadline for space for farm, community and floral display is August 1st, not April 11th as reported. Sorry! Mr. and Mrs. Cliff Toskey will be head of the Program Dept. for the Lacamas Fair.

All You Can Eat
Spaghetti dinner on April 27th is from 5 to 8 p.m. in the Lacamas Community Hall on the Harts Lake Loop Road. Real live entertainment while you eat all the spaghetti you can. Where else could you get a bargain like this for just a small donation? For more information call Roy 686.

Congratulations
Congratulations go to Judy Corbin who received a 10d ribbon from the Lacamas area in the 4-H Meal Preparation contest.

Field Trip
Remember Forestry kids—field trip April 13th to the State Game Farm and Fish Hatchery, Steilacoom, 9:45. Bring your record books as we will try to also have a short meeting afterwards.

Good Turn Out
There was a good turn out at the game night which was held April 5th. Everyone had an enjoyable time.

Workcamp At Spanaway Methodist Church

The high school youth fellowship of the Spanaway Methodist Church is planning a week-long workcamp over the spring vacation. They have invited 25 high school students from the Sandpoint Community Church in Seattle to join them in the work. The group will be painting, cleaning, and landscaping the building and grounds of the Spanaway Methodist Church.

The Seattle youth will be the guests of various families in the community. In addition to the work activities many recreational and spiritual activities have also been planned, including a party and dance at the church, a progressive dinner, a workshop on youth work, a splash party at the University of Puget Sound swimming pool, and an evening songfest.

Because the spring vacation falls during Holy Week, the workcamp youth are planning a special observance of Maundy Thursday. They will serve a symbolic Meal in the Upper Room for the adults of the community, as a service of remembrance of the Last Supper. Communion will also be served at that time by the pastor, Rev. Qualley.

A picnic, followed by outdoor recreation is planned for one of the afternoons.

Sunday evening, March 24, nine students from Spanaway visited the Sandpoint Church in Seattle to make further plans and arrangements for the workcamp week. The group included Andy Ashmore, president of the youth fellowship Monty Critchley, Gary Powell, Tom Carey, Mike Lamka, Patty Mason, Joy Morris, Barbara Grisbach, Judy Gray, and three adult counselors: Mr. Ashmore, Mr. Ralph Mason, and Mr. Orville Critchley.

The week of work began Monday morning at the Spanaway Methodist Church, and will conclude on Friday afternoon. All interested high school youth in the community are invited to participate.

Style Show Termed Success

Friday evening, March 29th, the Mother's Club of Central Avenue Preschool presented its annual spring style show. Many thanks are extended to the following people for their hard work and the time that they gave to the success of the show.

The general chairmen for the show were: Mrs. Clayton Hosler and Mrs. Norman Adams. Other chairmen were: Stage, Mrs. Byron Hovies and Mrs. John Rajcich; Co-ordination and script, Mrs. Robert Adler, Mrs. Dennis Adler and Mrs. Palmer Skaar; Publicity, Mrs. Robert Knoblauch, Mrs. George Connors, and Mrs. Frank Hooper; Luncheon tables, Mrs. Ronald Bush, Mrs. Stanley Moyer, and Mrs. Donald Tavern. Serving the refreshments in the cafeteria were Mesdames Earl Nielsen, Jack Parker, Gordon Hoar, Don Ashby, Grant Lyle, Mel Gillespie and Dean Herrington.

The Garden Shop was operated by Mesdames Thomas Schuster, Lawrence Larsen, Paul Shirley, Nobel Vickers, Henry Olstead, Clois Hosler, and J. Miller.

There were some 85 participants in the style show and more than 170 home sewn garments were fashioned.

The background was painted by students of Franklin Pierce High School art department. The music accompaniment was played by Wally Stricklin.

A special thank you is extended to all who participated in the style show and to those who attended.

Try not to become a man of success but rather try to become a man of value.

About the workcamp, Rev. Qualley said, "This workcamp will demonstrate to our community that most teenagers are responsible and fine citizens. They are willing workers," he said, "and concerned about spiritual values."

HOLY WEEK SERVICES

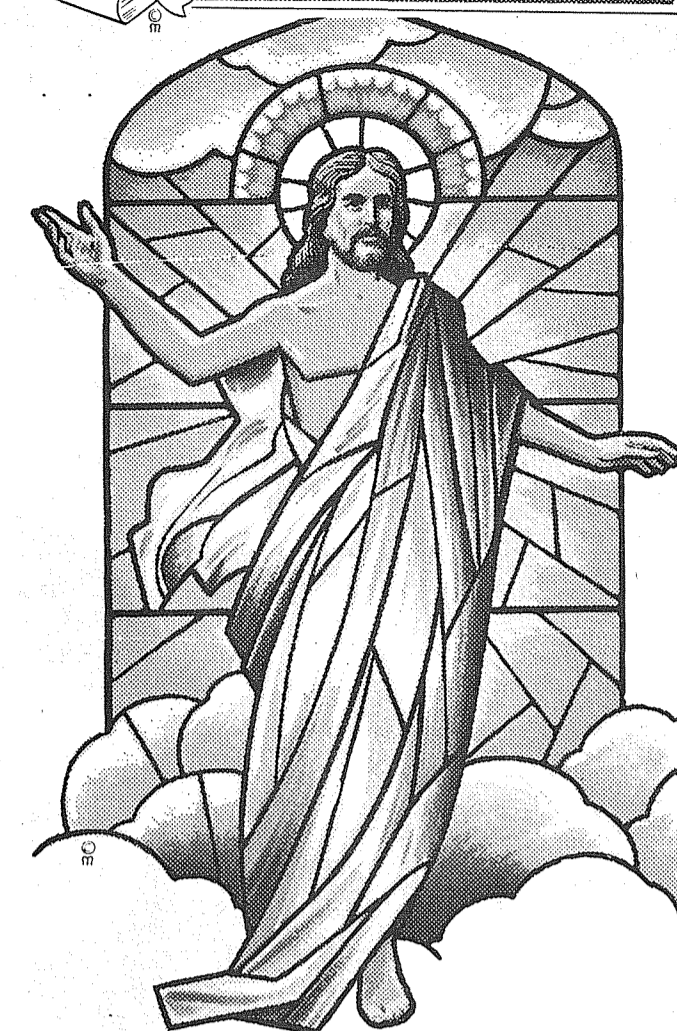

IMMANUEL BAPTIST CHURCH
9442 Pacific Avenue
REV. ALLEN HULL

Good Friday Service 7:30 p.m.
Easter Sunrise Service 5:45 a.m.
Morning Worship 8:30 a.m. and 11:00 a.m.
Choir Cantata 7:30 p.m.

EVERGREEN BAPTIST CHURCH
92nd & Waller Road
LEnox 7-4095
REV. VIRGIL IVERSON, Pastor

Sunrise Service 6:00 a.m.
Easter Breakfast 7:00 a.m.
Worship Service 9:00 a.m.
Topic: "The Living Lords".
Sunday School 9:45 a.m.
Worship Service 11:00 a.m.
Young Peoples Service 6:15 p.m.
Evening Inspirational Service 7:30 p.m.
Topic: "It Isn't All Bright".

Holy Week Services
PARKLAND METHODIST CHURCH
1218 1/2 "A" Street

Maundy Thursday Communion 7:30 p.m.
Sunrise Service 6:00 a.m.
Little Spanaway Park
The Rev. Paul Campbell, preaching.
Morning Worship 9:00 a.m. and 11:00 a.m.
Sermon: "Where Have You Laid Him?"
Church School on Easter Sunday 9:00 to 10:15 a.m.
(The regular hour is 9:30 to 10:45 a.m.)

SPANAWAY LUTHERAN CHURCH
JOHN BRIEHL, Pastor

SPECIAL MUSIC:
Senior Choir of Spanaway Lutheran Church.

Sunday School 9:30 a.m.
Church 11:00 a.m.
Coffee Hour After Services

Our Lady Queen of Heaven Church
14601 A Street, Tacoma, Wash.
FATHER WILLIAM GREIR
HOLY WEEK SERVICES:

HOLY THURSDAY: 6:30 p.m. High Mass, Communion and Procession.
GOOD FRIDAY: 6:30 p.m. Liturgy of the Passion and Death of Our Lord. Holy Communion and Stations of the Cross.
HOLY SATURDAY: 3:00 - 5:00 and 6:30 - 7:30 p.m. Confessions. 10:45 p.m. Easter Vigil Service: Blessing of the Fire, Blessing of the Paschal Candle and of the Baptismal Water. Renewal of the Baptismal Promises.
12:00 midnight: High Mass.
EASTER SUNDAY: 8:30 a.m. Mass and 10:30 a.m. Mass.

ELK PLAIN COMMUNITY CHURCH
On Mountain Highway TH 5-1641 (Res.)
DANIEL R. COOPER, Pastor

Welcome to Our Easter Sunday Services
Sunday School, April 14th 10:00 a.m.

Children's Program
Parents are invited
Easter Service 11:00 a.m.

TRINITY LUTHERAN CHURCH
12115 So. Park Avenue
ERLING C. THOMPSON, Pastor
LEnox 7-0201
THEODORE GULHAUGEN, Visitation Pastor

A Cordial Invitation Is Extended To The Entire Community THURSDAY IN HOLY WEEK
April 11, 7:30 p.m. Celebration of Holy Communion.
GOOD FRIDAY
April 12, 9:30 a.m. Special Children's Service (Adults welcome).
7:30 p.m. Evening Service.
EASTER SUNDAY
April 14, 6:00 a.m. Sunrise Service (breakfast following).
9:30 Easter Festival Worship Service
11:00 Easter Festival Worship Service
12:30 Holy Communion
EASTER MONDAY
April 15, 10:00 a.m. Norwegian Easter Worship Service.
23rd, David!

Canyon Ready Mix, Inc.
LE 7-3943

72nd & CANYON
Saturday Delivery

Fast Service -
- Quality Products
(ALL TRUCKS RADIO EQUIPPED)

Call For Estimates

BUILDERS SUPPLIES
PLYWOOD LUMBER
ROOFING HARDWARE
PLUMBING ELECTRICAL SUPPLIES

Baskett Lumber
9701 Portland Avenue
LE 7-8663

Kathie Jones College Home Ec Treasurer

Mrs. Frank Gural
LE 7-5989

Kathie Jones, daughter of Mr. and Mrs. Ralph Jones, was elected treasurer of The Washington Home Economics Association, College Division, at a convention held in Tacoma at the UPS campus last week end.

Kathie is a junior at Western Washington State College in Bellingham and is majoring in Home Economics. She graduated from Franklin Pierce in 1960.

Orthopedic Sells Gifts
The Midland Orthopedic Guild would like to remind Club will hold its regular

their many friends of their handmade gifts on sale at the Southeast Mutual Water Company office, on East 99th and Washington Streets. For Easter and Mother's Day, the Guild has many beautiful gifts such as aprons (fancy and utility), towel sets, pot holders, pillow cases, and many other fancy pieces. All proceeds of these gifts go to the maintenance of Mary Bridge Children's Hospital.

It's A Boy!
Congratulations to Mr. and Mrs. Norman Frink on the birth of their son, Norman LaVern, born April 3rd at the Tacoma General Hospital. The baby weighed in at 7 pounds and 2 ounces, and is greeted by sisters Diana and Laurie. Grandparents are Mr. and Mrs. LaVern Frink and Mr. and Mrs. Jim Baker.

Midland Community Club
The Midland Community monthly meeting on Wednesday evening, April 10th, at 8:00 p.m., at the Club Hall, with Alfred Heimburger presiding. Harvard and Midland residents are urged to attend, and new members will be welcome.

Seattle Visitors
Visiting at the home of Mr. and Mrs. Ralph Jones last Sunday were their daughter and son-in-law, Mr. and Mrs. Jack Armstrong, and Ramona from Seattle.

Judi Shoe "Capped"
Judi Shoe, a junior in Dental Hygiene at the University of Washington, was "capped" in a ceremony held in the lounge of the Dental Hygiene students in the class, who will graduate in 1964.

Judi is the daughter of Mr. and Mrs. Elmer Shoe and is a 1960 Franklin Pierce High School graduate, and former Daffodil princess.

Rummage Sale
St. John of the Woods Altar Society will hold a Rummage Sale at their Parish Hall, 99th and East Taylor, on Monday and Tuesday, April 22nd and 23rd, between the hours of 9:00 a.m. and 5:00 p.m.

Sympathy
Deepest sympathy is extended to the family and friends of George Lind, Sr., longtime Midland resident, who passed away last week. He was the founder and owner of the Midland Oil Sales Company, and was a member of many Midland organizations.

Omitted
Omitted from the list of Scouts of Midland's Troop No. 84 at Mount Rainier on March 23-24 was David Nygard. Sorry, David!

FOR HOME LOANS

SEE

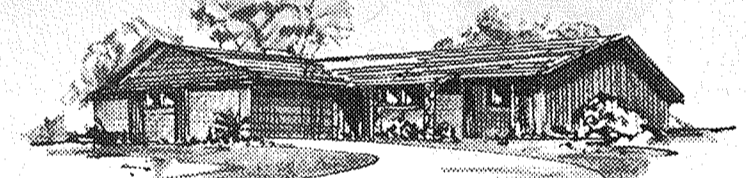

NATIONAL BANK OF WASHINGTON

Let National Bank of Washington help you finance the purchase of your next home. Home loans are now available on the following basis:

CONVENTIONAL HOME LOANS . . . to 20-year maturities naturally, no discounts.

FHA HOME LOANS . . . to 30-year maturities on new homes, or up to 10 years old—10% down—no discounts less than 10% down—competitive discounts

Stop in soon at any office of National Bank of Washington where the home loan officers are willing and able to service your mortgage credit needs!

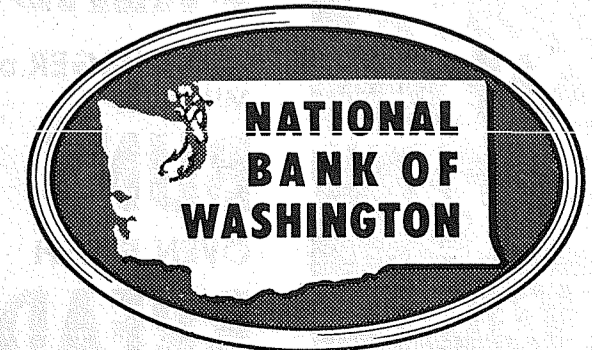

Member Federal Deposit Insurance Corporation • Member Federal Reserve System

A Date To Remember SATURDAY - SUNDAY AUG. 3-4

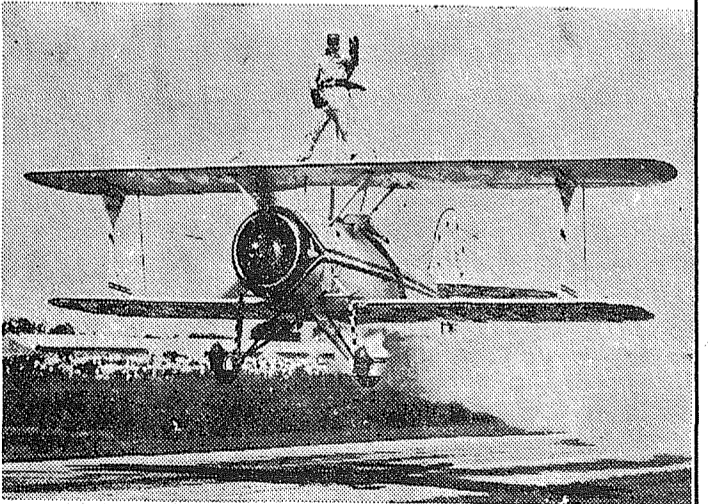

See The
NATIONAL AIR SHOW
At
THUN FIELD
PUYALLUP

Collins 4-H Bake Sale At Summit

Mrs. Fred Most
LE 7-7552

A son was born March 22nd to Mr. and Mrs. Gary Gillespie. Two brothers, Gary and Billie, welcomed the new baby, and grandparents, Mr. and Mrs. Roy Anderson of Collins and Mr. and Mrs. Walter Gillespie of Moses Lake.

Reported Ill

Mr. Marion Owen is reported ill in Tacoma General Hospital.

Bake Sale

The 4-H girls will hold a bake sale Saturday, April 13 at the Summit Thriftway Store beginning at 10 a.m.

Mrs. Svinth

Sympathy is extended to the family of Mrs. Edna Svinth who passed away recently. One son, Peter Svinth Sr., and grandson Peter Jr., reside in the Collins area. She is survived by seven sons and three daughters.

Home From College

Jerry Manley is home for Easter vacation from Western Washington College at Bellingham. He is the son of Mr. and Mrs. Matt Manley Jr. Ricky Manley, the other son, is back in school after an illness with an infected throat.

Injures Foot

Rhoe Ann Earle, daughter of Mr. and Mrs. Walter Earle, suffered a painful injury to her foot in a school accident Wednesday.

Honor Birthday

A family gathering honored the birthday of Mrs. Ellsworth Campbell on Sunday, April 7th.

Visit In Seattle

Mr. and Mrs. Ellsworth Campbell, Marvin Campbell, Bradley Tate and Mrs. Fred Most visited in Seattle Sunday with Mrs. Alice Taylor, daughter of Mr. and Mrs. Campbell.

Explorers Meet

Accidents on the highway will be the subject of a film shown by the State Patrol to members of Explorer Post 192 when they meet April 15th at the Collins Grange at 7:30 p.m. A second film also shows scenes from the "Columbus Day" storm. The public is welcome.

Self-Employed Farm Tax Eyed

Most farmers must pay a Federal self-employment tax for 1962, Neal S. Warren, Director of Internal Revenue for Seattle District, reminded them recently.

He said the rate of self-employment tax is 4.7 percent, and is in addition to any income tax payable.

Social Security taxes are paid by employees and their employers, and the self-employment tax must be paid by persons who are self-employed. These taxes are used to pay old-age, survivors and disability benefits under the Federal Social Security program.

A self-employed person is one who operates his own business or farm. A farmer is considered to be self-employed if he employs others to operate or work the farm, even though he does not live on it himself.

If earnings from self-employment are \$400 or more for the year, he must file a Federal income tax return and pay the self-employment tax due even though he owes no income tax.

The Country Parson

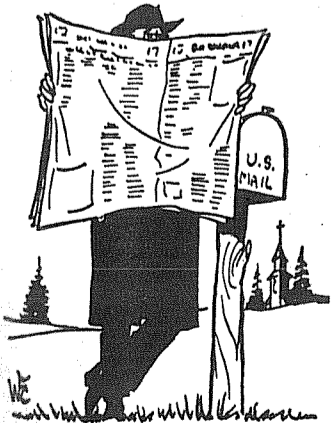

"The world is full of problems we'd like to solve — in the order of their nearness to us rather than their seriousness."
Copyright, by Frank A. Clark

**DRYER'S FUNERAL
PLAN CUTS COST**

Dryer MORTUARY
134th and Pacific
PARKLAND

Store Hours:
OPEN EVERY NITE TILL 9 P.M.
SHOP SATURDAYS TILL 6 P.M.
SHOP AND SAVE

SHOP-ETTE
13322
Pac. Ave. DEPARTMENT STORE Parkland
In The Lucky - Shop-Ette Shopping Center

Store Hours:
OPEN EVERY NITE TILL 9 P.M.
SHOP SATURDAYS TILL 6 P.M.
SHOP AND SAVE

EASTER GIFT PARADE



MENS SPORT SHIRTS

Knits and Drip Dries. Latest Spring colors. High style assortment. Sizes Small, Med. & Large.

1⁹⁹ To 2⁹⁹

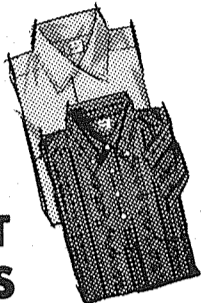

MENS FANCY TIES

Latest styles, colors and fashions. Four-In-Hand and pretied.

YOUR CHOICE 1.00



GIRLS EASTER BONNETS

Fancy straws trimmed with lace and flowers. Assorted styles to match that Easter outfit.

98¢ And 2.99



GIRLS DRESSES

Twelve dacrans, nylons and cottons. Latest Spring fashions and colors.

PRICED FROM 2.99 To 4.99



BOYS WHITE SHIRTS

Snap Tab Collars. Finest Quality. SIZES 6 TO 16 1⁹⁹



LITTLE GIRLS HAND BAGS

Assorted styles and colors for matching that Easter outfit.

99¢

EASTER CHOCOLATE RABBIT

Pure Chocolate. Tasty & Delicious. Individual Boxed.

Each 29¢

EASTER ORCHIDS

LOVELY IMITATION ORCHID DELICATE TONED COLORS FOR GIFTS & CORSAGES

10¢ Each

Ladies Pleated SKIRTS

STYLED BY "ARNEL" White only. Washes easily by hand or machine.

SIZES 8 TO 14. 5.99

Ship and Shore BLOUSES

FOR LADIES Perfect travelmates. New Spring assortment. Latest styles and fashions.

COMPLETE SIZE RANGE 3.98

Infants CRAWLERS

Gay spring patterns and styles. Drip dries and denims.

SIZES 9 MONTHS TO 18 MONTHS 88¢

LOVABLE LADIES STRETCH BRIEFS

100% nylon. Colors Black, Petal Pink, Sky Blue, Scarlet and Snow White. For that perfect fit.

1⁰⁰ Pair

Cannon Seamless NYLONS

Colors: Cinnamon and French beige. 400 needle, dress sheer.

SIZES 8 1/2 to 11 99¢ Pr.

PLAIN EASTER BASKETS

Many Unusual Styles & Shapes To Choose From.

10¢ To 69¢

Easter Grass

Giant Size Package Green, Yellow & Purple. In Tri-Color Pkgs. Celophane and Shredded Wax.

Pkg. 29¢

Easter Cards

Remember those loved ones with a personal Easter Card, from our large selection.

PRICED FROM 10¢ To \$1

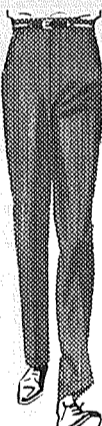

MENS DRESS SLACKS

Pleated and plain front styles. Slims & Regulars. Finest Wash and Wear fabric.

COMPLETE SIZE RANGE 8⁸⁸ Pair

CHILDRENS CANVAS Play Shoes

Colors Red, White, Blue. Heavy rubber sole. Durable canvas uppers.

SIZES 5 TO 12 77¢ Pair

IMPORTED WICKER CLOTHES BASKETS

Round Shape - Giant Size Hand Made. Heavy Duty Quality.

88¢

PLASTIC FRUIT

11 Piece Assortment. Life size pieces. True natural colors.

66¢

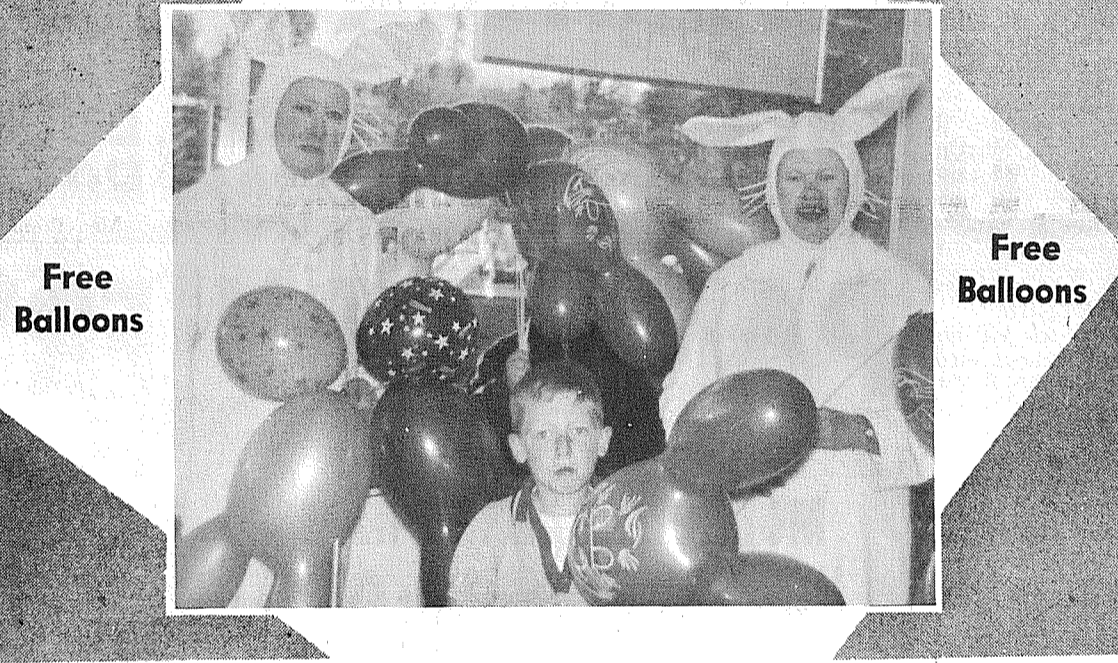

Free Balloons

Mr. and Mrs. Bunny Rabbit Will Be At ShopEtte Store From 10 A.M. To 6 P.M. Saturday

WITH THIS COUPON 10 A.M To 6 P.M. Saturday One 5x7 Photograph Of Your Child FOR ONLY 88¢

We have so many

EASTER TREATS

EASTER EGG DYE 15¢ A Pkg.

EASTER EGG DYE 29¢ A Pack.

FILLED EASTER BASKETS 49¢ PRICED FROM

EASTER PLUSH TOYS 29¢ PRICED FROM

EASTER CANDY EGGS 39¢ A PACKAGE



LADIES NYLON SLIPS

Shadow paneled. lovely lace trim, dainty soft colors.

SIZES 32 to 44 1⁹⁹

LADIES Petti Pants

Solid colors, lace trim, and dainty floral pattern with lace trim; latest fashion.

SIZES SM, MED., & LARGE 99¢ Pair

LADIES PERFECT BRAS

Designed by Wings. All white, long wearing, perfect fit; guaranteed.

Sizes 32A to 38B 1⁰⁰

LADIES GLOVES

White only. Soft spun, pre-shrunk, double woven cottons.

SIZES 6 1/2 TO 8 1²⁹



SHOP-ETTE

13322 Pacific Ave. DEPARTMENT STORE Parkland
In The Lucky - Shop-Ette Shopping Center

The TIMES JOURNAL

ADDRESS P. O. BOX 2008, PARKLAND, WASHINGTON
14620 Pacific Avenue Phone LEnox 7-0223
JACK BROWN Publisher
NEIL McLEAN General Manager
RUTH THOMPSON Editor
WAYNE JOHNSON Circulation
CHET CHAMBERLAIN Accounting
DAVE HIBBARD Shop Superintendent
DICK MARCELLE Composing Room Foreman
Qualified as a Legal Publication under Chapter 213 of the Legislative Acts of the 1941 Regular Session of the State of Washington.
Delivered free by U.S. Mail, or carriers, to all homes in the trade territory. Paid subscriptions elsewhere: In Washington State \$2.50 per year. Outside the state, \$3.00 per year.

ADVERTISING RATES ON REQUEST

a - Wondering and a - Wandering

with Jack Brown

For years I have had a yen to go watch the Sammamish Slough boat races but never could quite see driving that far just to set on the bank and watch the boats flash by one given point. Last Sunday as I read an account of the races, accompanied by the usual pictures showing some joker climbing the bank with his boat, inspiration hit. I tossed the kids into the plane and headed for the Redmond area.

My timing was perfect. One race was just starting from Lake Sammamish to Lake Washington. I dropped down over the creek bank and by leisurely circling the boats we were able to watch them from a few hundred feet all the way down to Lake Washington. We watched them make each hairpin turn, saw one boat climb a bank and thoroughly enjoyed every minute of the race. From a spectator's standpoint this method of watching the race is unsurpassed. All I had to watch for was not to fly over the crowds or any home at low altitude. I think I'll take in a few more sporting events from the air, that is if some do-gooder in Olympia doesn't decide to pass a law against it.

Another observation made the same day.
After the races I landed at Snohomish to fill up the kids at the local beanery. Just as we walked in the door a train came roaring down the nearby tracks and my two youngest stood rooted to the spot until every last car had faded from sight. Here were two kids that had just completed a thrilling afternoon in the air and yet an old freight instantly captured their eye and their imagination as they put themselves in the engineer's seat, mentally. Kids will never change!

On the ground the other day just out of Everett, my oldest monster son happened to catch sight of a sign advertising sea food. He volunteered to cook our dinner that night if I'd buy the necessary ingredients, so I instantly agreed. I pulled off to make the necessary purchase and as I placed my order I spotted some old fashioned alder smoked salmon. A large price tag on the fish plainly showed 48c and it registered with me that a pound of it would make good munching material on the rest of the drive, so long as I kept a window open. I told the clerk to toss in a pound of the salmon, too. When he totaled up my bill I thought he was quoting me the national debt. Seems sea food is high, at least up Everett way. Anyway, I asked him if he'd given me only a pound of salmon and he assured me that he had. I walked the length of the counter and "Ah, so!" the mystery was solved. The big 48c figure had 1/4 pound printed under it in very small print. I paid up, shut up and shoved off, but couldn't help thinking about the smoked salmon.

When I was a kid going to school, smoked salmon was a status symbol. Each noon hour as all of us opened our lunch boxes the room would take on the tantalizing aroma of the city dump, as kid after kid pulled out a big chunk of smoked salmon, and the teacher slipped outside for air. Yes, it was a status symbol of us who had nothing else to eat during those tough depression times. Salmon were abundant in those days and we carted them off by the load to smoke for the winter at a net cost to us of a bag of salt. A chunk of smoked salmon had about as much value from a monetary standpoint in those days as a tick did on a hound dog.

Now it seems the lowly chunk of smoked salmon has risen from the status symbol of the hungry swab to that of the gourmet. Who says it isn't a changing world?

You've all heard the old cliché about cheering up, things could be worse, and the age old ending of the story. I believe it was really written for me, even though it took several years for the climax.

As the story goes, I was sitting in my office last week with my feet on the desk, contemplating some personal problems that at the time were paramount in mind, like how to raise a family single handedly, when one of the jokers that works here . . . let's rephrase that . . . One of the jokers that puts in his time around here, came thru the office and made the ageless remark, "Cheer up, boss, things could be worse." It brought a smile to my face as I thought of the usual ending, but it did make sense, so in a matter of minutes I erased the morbid mental block I had and actually I did just that . . . I cheered up, and sure enough . . . things did get worse. Within a matter of minutes some character served me with papers wherein it was indicated that someone still believes in Santa Claus, for I am being sued for nearly a quarter million dollars, and that will make a lot of nectar. While I'm standing there looking this over, who pops in but Harold LeMay with a buddy in tow looking for a \$500 donation for the Boy Scouts. A good cause and a great need, but needless to say, with timing like that, all they got was the use of my crying towel.

As Harold and his buddy waded out of the joint the phone rang and we were informed that CBS had changed the dates on the showing of the National Air Show. With this news I sat down, my mind filled with the vision of thousands of you readers glued to your seats on Sunday afternoon, waiting for a well advertised show that wouldn't materialize, and then gunning for me on Monday morning. And that's the way it came to pass before we got this week's paper out with a correction.

Since then things have been real fine, with some minor factors like the gas tank in the plane busting open necessitating major repairs, my kids catching a pan of grease on fire and smoking up half the house and my number one son creaming one of the company cars.

As I sit here waiting patiently for the roof to cave in or a logging truck to come driving thru the front door, I can't help but have fears for the well being of the next egg head that pulls the old "Cheer Up" bit on me.

George Walk Installed As Master

Mrs. Verne Fogle LE 7-5210

State Grange Deputy Masters Frank Ballou and Maurice Rheinhardt, with Master David Van Hulle looked on as George Walk Jr. accepted the gavel as newly installed Master of Waller Road Grange, launching the group on their first year of activity.

The Gig Harbor Juvenile Grange, headed by Phillip Marcum, received many compliments on their performance, last Sunday, when they initiated members of Waller Road and installed the officers.

Mrs. Bessie Scott, Juvenile Matron and Mrs. Dorothy Bryant, Gig Harbor, Pomona Matron, assisted the group.

Mrs. Nancy Olsson, was installed as Juvenile Matron for the newly organized group. Her assistant will be Mrs. Hazel Walk. The Juvenile Committee of the Senior Grange are Mrs. Rudolph Geise, Mrs. George Walk Sr., Mrs. Thurman Simpson and Woodrow Farrington.

A reception followed the meeting, where young and old alike, shared in the beautifully decorated cake made by Mrs. Roy Nelson, and ice cream (compliments of Frank Ballou) and dainty sandwiches furnished by members of the Grange. Also coffee and drink for the children. Hostesses were ladies of the Grange.

Dedicated Helpers

Behind the scenes of any successful production stands a lot of cooperation by dedicated people. The Committee in charge of the Waller Road P-TA Carnival headed by Mrs. James Smith, wish to take this opportunity to extend a hearty "Thank You" to all who gave their support.

A special thanks to Mr. Richard Frank in charge of the kitchen, his capable committee and to those who made contributions of food, cakes for the cake walk, and miscellaneous articles used throughout the carnival.

Appreciation also goes to Principal Florence Martin, and the teachers of the school, who so willingly gave of their time and talents to make the carnival the outstanding event of the year.

Special Election

There will be an all important, special school election held Tuesday, May 14th at Waller Road School. If you are not registered, do so immediately. Drop by Neil Husted's place at 6018 Waller Road. He is the registrar for the Waller Road area. Those qualified are urged to register. If you have been a resident of the State for 11 months, the county for 60 days and the precinct one day, you are qualified.

Newcomers

Mr. and Mrs. Harry E. Miller, parents of Mrs. Al Ferch have sold their home in University Place and are moving into a home at 6206 36th Ave. E., in the Waller Road area.

Remodel Now & Save PARKLAND BUILDERS

Remodeling Specialists
No Job Too Large or Too Small!
CALL LEnox 7-7965
FREE ESTIMATES

Rely on your PHARMACIST

IT'S A PLEASURE TO HAVE PRESCRIPTIONS FILLED AT
ASHMORE DRUG

SERVICE IS ALWAYS COURTEOUS AND PROMPT!



ASHMORE'S SPANAWAY Drug
165% & PACIFIC Ave. SPANAWAY
LE 7-5993

Lucky

7 DAY SPECIALS

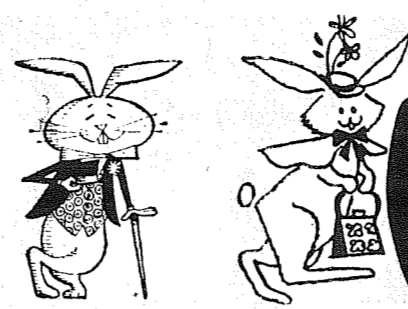

GET READY for the

FAMOUS BRAND FOODS AT ROCK BOTTOM PRICES!

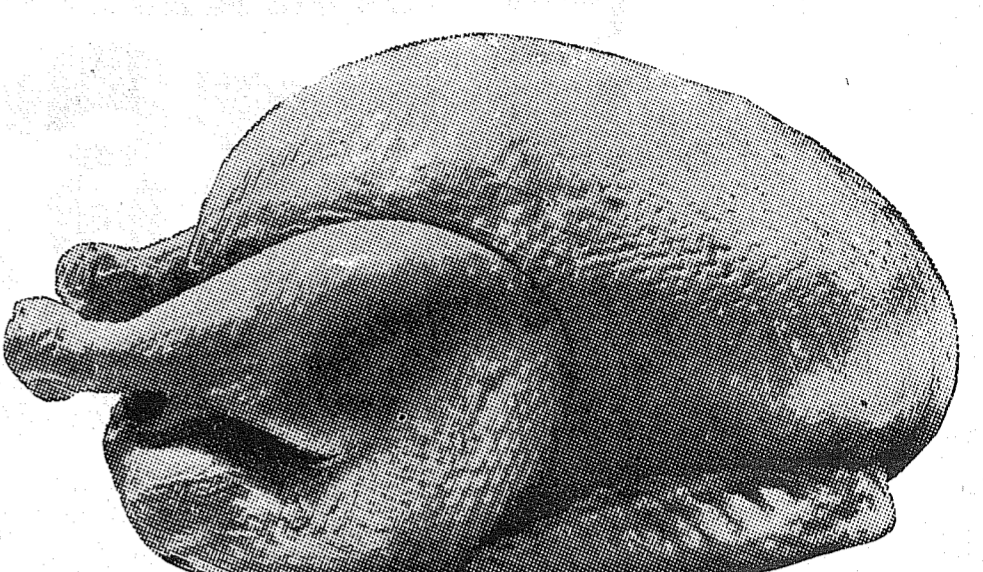
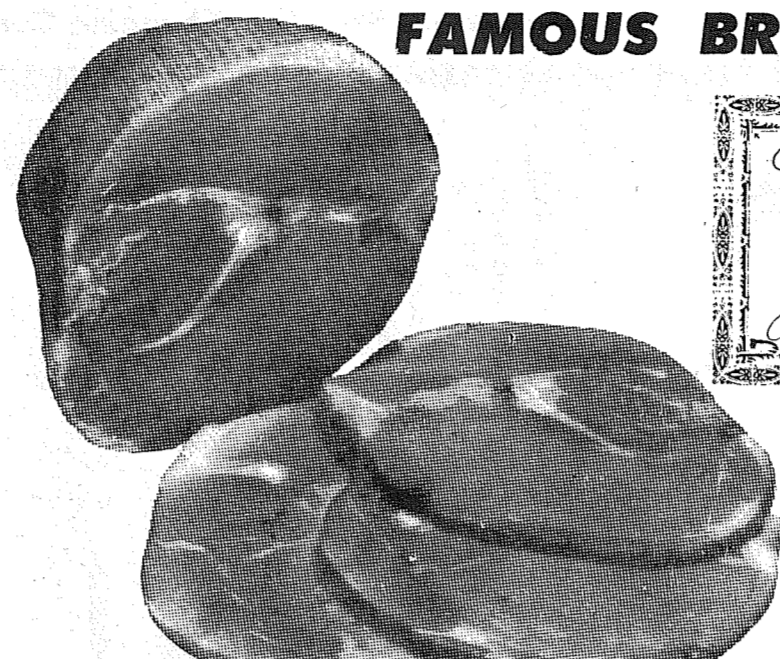

Boneless Ham

ARMOUR STAR TENDER, LEAN ANY SIZE PIECE

OUR BEST HAM VALUE

65^c

lb.

Fresh Turkeys

GRADE 'A' YEARLING

12 to 17 lbs.

EXCELLENT BUY!

39^c

lb.

FRESH GROUND BEEF

Choice Top Round

89^c lb.

U. S. Choice

79^c lb.

lb. 39^c

BNLS ROAST RUMP ROAST

Choice Top Round 89^c lb.

U. S. Choice 79^c lb.

LUCKY BACON

1 lb. Pkg. 53^c

RED SNAPPER KING CRAB

FRESH 39^c lb.

FRESH 89^c 8-oz. Pkg.

PAN-READY FRYERS

WASHINGTON FRESH GROWN CUT-UP

lb. 39^c

MORRELL CANNED HAM

SAVE 80c ON BONELESS, CANNED, 5-LB. HAM ONLY

\$3.98 WITH THIS COUPON

REG. \$4.78 CASH VALUE 1/20 OF ONE CENT

GOOD ONLY UNTIL APRIL 17th AT LUCKY STORES

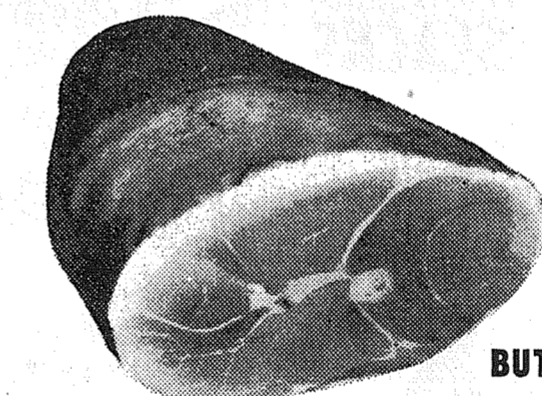

SWIFT'S PREMIUM Hams

FULL SHANK HALF 6- TO 8-LB. HALVES

lb. 43^c

BUTT PORTION . . . lb. 53^c WHOLE, 12-16 lbs. . . lb. 49^c

TOP QUALITY FRESH Asparagus

CALIFORNIA'S FINEST TENDER AND FULL FLAVORED

15^c

lb.

NEW POTATOES Florida Red Bliss or Calif. White Rose 10 lbs. 59^c

HEAD LETTUCE Crisp Large Heads . . . 2/25^c

FRESH TOMATOES Florida Vine-Ripened . lb. 23^c

SOUTHERN YAMS U.S. No. 1 Even Sized . . . 2 lbs. 29^c

CELERY HEARTS Crisp Hearts of Pascal Celery bu. 29^c

FRESH CUT DAFFODILS AT ALL STORES

PREMIUM QUALITY EASTER LILIES

THE VERY FINEST SELECTED 3-AND 4-BLOOM IN COLOR-FUL FOIL-WRAPPED POTS - ECONOMICALLY PRICED AND PERFECT FOR EASTER GIVING.

SERVE THE FINEST S&W, OF COURSE SHOP THESE SPECIALS!

S&W Oven Baked Beans 28-oz. Can . . . 3/\$1 S&W GREEN PEAS No. 303 Can . . . 4/99^c

S&W Cucumber Pickles Sliced 12-oz. Jar . . 4/\$1 S&W Red Kidney Beans No. 303 Can . . . 6/\$1

S&W Tomato Juice 29-oz. Can 4/\$1 S&W GOLDEN CORN Whole Kernel No. 303 Can . . . 5/\$1

S&W TOMATO CATSUP 14-OZ. BOTTLE 5 FOR \$1

Commercial and Residential Wiring
Electrical Supplies

We Install and Recommend
ELECTRO-RAY BASEBOARD HEAT
WEBB ELECTRIC CO.
(CONTRACTOR)
24-HOUR EMERGENCY SERVICE
11112 Pacific Ave. LE 1-1133

EASTER PARADE

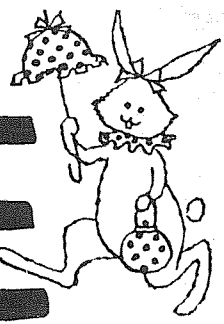

NOTICE . . . WHITE CENTER LUCKY
OPEN EASTER SUNDAY, APRIL 14th—
ALL OTHER STORES CLOSED.

ALL PRICES IN THIS AD ARE
EFFECTIVE THURSDAY THRU
NEXT WEDNESDAY, APRIL 17th

LOOK! Here are bargains by the basketful for your Pre-Easter shopping and these items are the finest quality in brands you recognize at the lowest prices possible. We Have Everything To Make Your Dinner A Real Success!



DON'T FORGET
EASTER EGG DYE!

STRICTLY FRESH

FRESH FROM THE RANCH!

MEDIUM GRADE "AA"
EGGS DOZ. **33**¢
CTN.

LIMIT 3 DOZEN AT THIS PRICE

LARGE GRADE "AA"
EGGS DOZ. **39**¢
CTN.

LIMIT 3 DOZEN AT THIS PRICE

These Are All Top Quality White Ranch Eggs; Everyone Guaranteed Absolutely Fresh For Coloring. SHOP LUCKY STORES AND SAVE MORE!

GENERAL MILLS
CEREALS

CHEERIOS . . . 10 1/2-oz. SUGAR JETS . . . 10-oz.
COCOA PUFFS . . . 8 1/2-oz. TOTAL . . . 8-oz.
HI PRO . . . 6 1/2-oz. TRIX . . . 8 1/2-oz.
KIX . . . 9-oz. TWINKIES . . . 9 1/2-oz.
FROSTY's . . . 9 1/2-oz. WHEATIES . . . 12-oz.

MIX OR MATCH PACKAGES

3 For 79¢

BISQUICK 40-oz. **39**¢
PKG.

PLUS . . . THESE ADDED ITEMS AT REDUCED PRICES!

FRUIT COCKTAIL Dole No. 303 can . . .	4/\$1	COFFEE Chase & Sanborn 4c off Reg. or Drip 1-lb. can . . .	59¢
PINEAPPLE Dole crushed No. 2 can . . .	31¢	PEANUT BUTTER Planter's 18-oz. jar . . .	57¢
SALAD OIL Lucky 38-oz. bottle . . .	59¢	Orange Delight Minute Maid frozen NEW! 6-oz. can . . .	2/35¢
BLEACH Lucky gallon jug . . .	49¢	SLICED PINEAPPLE Dole 1 1/4 Tin . . .	2/49¢
DINNER NAPKINS Scotkins paper pkg. of 50 . . .	25¢	ROYAL PUDDING Asstd flavors Reg. pkg. . .	10/89¢
CHEESE PIZZA Gino's frozen 12" size . . .	59¢	COCONUT Durkee 14-oz. pkg. . .	59¢
PINK SALMON Royal tall can . . .	59¢	VANILLA WAFERS Sunshine 12-oz. pkg. . .	3/\$1
CAKE MIX Duncan Hines Angel food 15-oz. pkg. . .	55¢	NOODLE DINNERS Betty Crocker 4 varieties pkg. . .	47¢
POTATO CHIPS Nalley's Triple pack pkg. . .	59¢	ALUMINUM FOIL Reynold's heavy duty 25' roll . . .	67¢
CORN CHIPS Nalley's Triple pack pkg. . .	59¢	SWEET POTATOES Taylor No. 3 Can . . .	31¢
MARSHMALLOWS Kraft Miniature 10 1/2-oz. pkg. . .	4/\$1	Kraft Cheese Sli. Swiss, Caraway, Cheddar & Monterey 6-oz. pkg. . .	3/\$1
BALLARD Biscuits Or Pillsbury 8-oz. pkg. . .	3/33¢	MAYONNAISE Nalley's 6c off Qt. jar . . .	55¢
PERSONAL IVORY 4c Off 4-bar pkg. . .	23¢	GRAHAM CRACKERS Nabisco 1-lb. pkg. . .	3/\$1
LAVA SOAP (REG. BAR . . . 3/35c) large bar . . .	2/33¢	MUSTARD French 9-oz. jar . . .	2/37¢
DREFT Detergent large pkg. . .	37¢	DUZ Detergent starter size . . .	62¢
JOY LIQUID Detergent 4c off 12-oz. bottle . . .	35¢	DOWNEY Fabric Softener 17-oz. bottle . . .	47¢

FRUIT DRINKS **HI-C BRAND** FRUIT PUNCH, ORANGE, GRAPE, ORANGE-PINEAPPLE OR PINEAPPLE-GRAPEFRUIT. LARGE 46-OZ. CAN. . . . **4/\$1**

THIS AD EFFECTIVE THRU NEXT WEDNESDAY!

ALL STORES CLOSED EASTER SUNDAY APRIL 14TH

SHOP YOUR PARKLAND LUCKY — 13320 Pacific Ave.

9 A.M. TO 11 P.M. DAILY — 9 A.M. TO 9 P.M. SUNDAYS

Lucky
7 DAY SPECIALS
LIMIT RIGHTS RESERVED

SCHILLING PRODUCTS FOR FLAVOR!

SCHILLING VANILLA EXTRACT	2-oz. Bottle	39¢
SCHILLING CAKE DECORS AND CRYSTALS	9 Varieties . . . Reg. Btl.	15¢
SCHILLING FOOD COLORS	6 Varieties 1-oz. Bottle	15¢

A COMPLETE ASSORTMENT OF DELICIOUS, QUALITY EASTER CANDY IS AVAILABLE AT ALL LUCKY STORES! SHOP WHERE ADS ARE EFFECTIVE EVERYDAY!

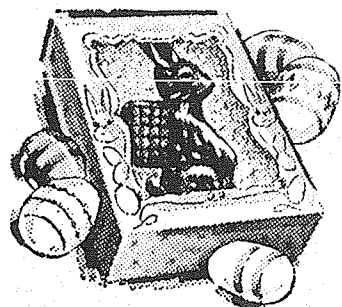

4-H Girls Schedule Bake Sale

Mrs. Ray Burkhardt VI 7-7386
The Elk Plain Girls 4-H will hold their annual bake sale at Lucky's Store, Saturday, April 13th from 11 a.m. to 5 p.m. Home baked Easter goodies will be on sale.
The Club meetings are held the second and last Wednesdays of each month. Mrs. Dave Parker is the leader.

Thank You
The family of Grandma Van Meter wish to express their appreciation and thanks for all the kindness and sympathy shown to us during our recent bereavement.
Mrs. Jessie Sartain and family, Mrs. Gertrude Smalley and family, Mrs. Edna Jones and family.

Special Program
A special Easter program will be presented by the Sunday school children at the Elk Plain Community Church on Easter Sunday at 10 a.m. Everyone is welcome.

The annual Sunrise Service will be held at Bethel Senior High School on Easter Sunday, April 14th.
Pastor Dan Cooper of the Elk Plain Community Church will be the speaker.

Following the service, a pancake breakfast will be held in the High School Auditorium.

Former Resident Passes
Charles Covington of Oak Harbor, Wash. died Sunday and will be buried at Oak Harbor on Wednesday at 10 a.m. He leaves his wife Susie, two sons and one daughter.

P-TA Meets
The Elk Plain P-TA meeting will be held on April 17 at 8 p.m. at the school.

Speaker for the evening will be Mr. Minniti, Principal of the Junior High School. His topic will be "Children Entering Junior High", their subjects, activities, behavior, etc.

Flying — With Slim Volunteers Needed In Roy Area

The San Juan Islands attracted two business flights from Spanaway this week. William Harris, Puyallup veterinarian, chartered the Mark 20 to Friday Harbor. Ron Peters in the 172 also to Friday Harbor.

Pat Bacon of Puyallup soloed a Tri-Traveler, making the completion of the first phase of his training to a Private License.

Dick Vanderflute, former Tahoma Flying Service student, checked out in the Mooney Mark 20 followed by giving a ride to his wife and son.

Al Tidmarsh, Boeing employee and former Airline Pilot for Pan American and Frontier Airlines, started a brush-up course to renew his instructor's rating.

Nat'l Forest To Auction Used Equipment

The Snoqualmie National Forest will conduct a public auction sale of seventeen units of used equipment.

The auction will take place at the North Bend Ranger Station, North Bend, Washington, at 10:00 a.m. Thursday, April 11, 1963. Inspection may be made at North Bend, from 9:00 a.m. to 4:00 p.m. on April 9 and 10, and from 8:00 a.m. to sale time on April 11.

Equipment included in this auction will be 1/2 3/4 ton pickups; 4x4 1 ton pickups; sedan deliveries; panels and a carryall.

Further information is available at the Supervisor's Office, Snoqualmie National Forest, 905 2nd Avenue Bldg., Seattle.

The secret of success is constancy to purpose.
—Benjamin Disraeli

Martha Berggren Roy 229

Saturday, April 13, beginning at 9:00 a.m. workers are needed to help get the Rodeo Arena ready for the P-TA Jr. Rodeo. Workers are needed to repair damage done to the fence by the wind storm in October, and cleaning up and rock picking are also big jobs. Volunteers are asked to come early and work as long as possible.

Good Cooks
Darlene Dale and Judy Corbin won a red ribbon on their breakfast which they prepared in the 4-H contest held recently at Keithley Jr. High.

Hicks Elected
Officers elected to serve in the Roy P-TA for next year are: Harvey Hicks, President; Dan Craddock, Vice-President; Mrs. Ruth Rotondo, 2nd Vice-President; Mrs. Ruby Reese, Treasurer; Mrs. Deloris Hawn, Secretary.

Forestry Topic
Dave Kemperer, Agriculture Agent in charge of Forestry, will speak at a meeting to be held in the Roy Grange Hall April 18. The meeting which is open to the public will begin at 8:30 p.m. following a short business meeting of the Grange. Mr. Kemperer will discuss Forestry practices and management and will have a question period.

Cadet Is Honored

Harold Dean Moreland, a graduate of Bethel High School and now a senior at the University of Washington, was recently designated a Distinguished Military Student in the Army ROTC program at the University of Washington.

Open Mon., Wed., Fri. 'til 8 p.m.

FRIGIDAIRE APRIL SHOWER OF VALUES!

THRIFTIEST 2-DOOR FRIGIDAIRE MAKES!

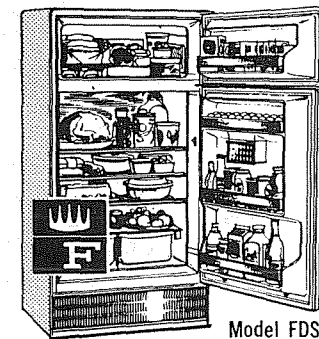

- Giant 100-lb. zero zone freezer.
- Automatic Defrosting refrigerator section!
- Twin produce Hydrators, deep-shelf storage door!

COLOR OR WHITE — SAME LOW PRICE! **\$249⁰⁰** W/T

2-SPEED, 2-CYCLE STURDY FRIGIDAIRE WASHER

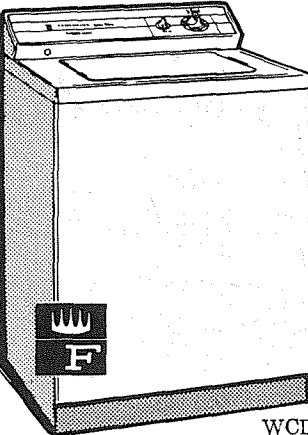

- 3-Ring Agitator action gets regulars and delicates clean—inside and out.
- Fresh running water rinses, automatic lint removal—and lots more.
- Ask us about 15-Year Lifetime Test!

COLOR OR WHITE — SAME LOW PRICE! **\$199⁹⁵**

WCDAS-1

FLAIR by FRIGIDAIRE

America's loveliest range—budget-priced!

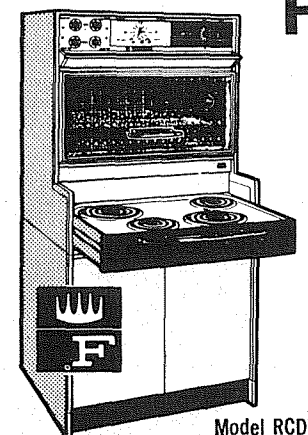

- Built-in glamour that installs in minutes.
- Eye-level oven with glide-up glass door and much more!

COLOR OR WHITE — SAME LOW PRICE! **\$299⁰⁰** W/T

Model RCDB-630-2 30-inch, electric

Base Cabinet Optional

POCHEL'S

Your Pioneer Fuel Oil, Auto Parts and Appliance Dealer.
140th & Pacific
LE 7-8624

Open Mon., Wed., Fri. 'til 8 p.m.

SELL AND PROFIT... BUY AND SAVE... GET A BETTER JOB... HIRE GOOD HELP!

Read and Use the Want Ads!

Page 8 The Times Journal Thursday, April 11, 1963

Personal (11)

THREE MONKEYS SUPPER CLUB—161st St. & Pacific Ave. Spanaway. LIVE JAZZ NIGHTLY by Peter Gruenstein, 9 p.m. till 1 a.m. Weekly, tell your strange experience at Saturday night 7:30 smorgasbord; Thursday, 2 to 5 p.m., FREE tea leaf readings; Tuesday nites, Chess, Checkers and Pinochle, 7 p.m.; Friday nites, Social mix, 7 p.m.; Science Fiction, 1st & 3rd Saturdays, 6:30 p.m. LE 7-0515. 1cft

Lost & Found (6)

LOST—Light grayish female cat. Reward. 722 So. 160th St. cat. Reward. 722 So. 160th St. 6p32

WANTED—Unlimited opportunities in selling. \$35.00 to \$100.00 weekly part time. Willingness to work main qualification. Military welcome. Interview by appointment. GR 2-7110. 5c32

Business Serv. (3)

HAIRCUT \$1. Bruce's, 110th and S. Yakima, Parkland. 3p32

PLOWING, discing, rotovating, leveling, light tractor work; LE 1-2963. 3c34

Want to Buy (8)

WANTED TO BUY Real Estate contracts. LE 1-2970. 8p32

WANTED—Coins, Lincoln, Indian pennies, all other old coins. LE 7-5068. 8cft

Real Estate (9)

HUGE water front tract. View of Mt. Rainier. Beautifully wooded in evergreens. Over 70 ft. of frontage on lake. Lights, water and hard surfaced roads included in purchase price. Private park with swimming pools, tennis courts, baseball fields and boat launching ramps. Only \$3,495. \$150 down, \$33.00 per month. Lake Tapps Sales Co. UN 3-7474 UN 3-6662. 9c32

770 SOUTH 110th—Beautiful rambler, fireplace, two large bedrooms plus a den. Beautiful patio with fireplace. Sell equity, FHA or GI. \$14,500, owner-agent. LE 1-1025. 9cft

Rentals

FOR RENT—Furnished one-bedroom house. \$35. No dogs. VI 7-2255. 10c32

FOR RENT—New house, 1 1/2 bedrooms, large closets, large front room and kitchen with formica top counter, 30" range, nice comb. refrigerator-freezer, new rug and nice furniture, all electric heat and fixtures. Part utilities. No pets. Baby welcome. \$75 a month. LE 7-5976. 10cft

FOR RENT—Newly decorated furnished two-room apartment. \$55. Call LE 1-1071. 10cft

Rentals

3304 So. 116th, 2 bed, \$95; 7213 Steilacoom Blvd., 1 bed, \$55; 11707 Pacific Ave., 1 bed, all bills paid, \$85.

UNFURNISHED 9040 South "D", 3 bed, \$85; 110 E. 129th, 3 bed, \$100; 231 So. 173rd, 2 bed, \$80; 1504 So. 110th, 2 bed, \$65; Rt. 1, Box 1626, 2 bed, \$60.

Rentals

FOR RENT—1-bedroom partially furnished house near Graham, \$50. VI 7-7215. 10c32

FOR RENT—Two room cabin, bath, mostly furnished, \$25.00. Mile South of Fruitland Grange 8619 E. 128th (Collins Road). 10p32

FOR RENT—One bedroom apartment, all utilities paid except gas for heat, \$45.00 plus deposit. LE 7-0259. 10c33

FOR RENT—Modern, roomy, 2-bedroom unfurnished home, near PLU, \$85.00. LE 1-1107. 10c32

FOR RENT—3 bedroom ramble, \$125.00; also, 1 bedroom brick, both on creek. 15401 Waller Road East. 10c32

TRAILER SPACES; also large 2-bedroom trailer for rent. Craney Crow Trailer Park, near Roy Y, East Gate, Fort Lewis, VI 7-7704. 10cft

FOR RENT—Furnished house, Box 1737, Spanaway Loop Rd. 10c32

FOR RENT—1 or 2 2-bedroom modern, \$67.50 to \$77.50. Furnished or unfurnished. JU 8-8962. 10cft

Income Tax Service

AT J. ELECTRIC FOR your wiring and electric heating needs, call LE 7-0349, or TH 5-2822. Free estimates. 3cft

FOR FURNACES, repairs, sheet metal work, call PARKLAND FUEL OIL. LE 7-0256. 3cft

FOUNDATIONS, ADDITIONS, REMODELING. Free estimates. Financing, no down payment. Ph: GR 4-7000 any time. 3cft

Rentals

FOR RENT—1-bedroom roomy furnished house near Graham, \$50. VI 7-7215. 10c32

FOR RENT—Two room cabin, bath, mostly furnished, \$25.00. Mile South of Fruitland Grange 8619 E. 128th (Collins Road). 10p32

FOR RENT—One bedroom apartment, all utilities paid except gas for heat, \$45.00 plus deposit. LE 7-0259. 10c33

FOR RENT—Modern, roomy, 2-bedroom unfurnished home, near PLU, \$85.00. LE 1-1107. 10c32

FOR RENT—3 bedroom ramble, \$125.00; also, 1 bedroom brick, both on creek. 15401 Waller Road East. 10c32

TRAILER SPACES; also large 2-bedroom trailer for rent. Craney Crow Trailer Park, near Roy Y, East Gate, Fort Lewis, VI 7-7704. 10cft

FOR RENT—Furnished house, Box 1737, Spanaway Loop Rd. 10c32

FOR RENT—1 or 2 2-bedroom modern, \$67.50 to \$77.50. Furnished or unfurnished. JU 8-8962. 10cft

Now at Siler's

Complete service on electric ranges. All makes. Fast, dependable, reasonable. LEnox 7-8634. 3cft

SEPTIC TANK, Drainfields, Sewer Installation. Luke, GR 2-7243. 3cft

DRESSMAKING and Alterations. Restyling, reasonable, 1515 So. 102nd. LE 1-1376. 3cft

Rentals

FOR RENT—1-bedroom roomy furnished house near Graham, \$50. VI 7-7215. 10c32

FOR RENT—Two room cabin, bath, mostly furnished, \$25.00. Mile South of Fruitland Grange 8619 E. 128th (Collins Road). 10p32

FOR RENT—One bedroom apartment, all utilities paid except gas for heat, \$45.00 plus deposit. LE 7-0259. 10c33

FOR RENT—Modern, roomy, 2-bedroom unfurnished home, near PLU, \$85.00. LE 1-1107. 10c32

FOR RENT—3 bedroom ramble, \$125.00; also, 1 bedroom brick, both on creek. 15401 Waller Road East. 10c32

TRAILER SPACES; also large 2-bedroom trailer for rent. Craney Crow Trailer Park, near Roy Y, East Gate, Fort Lewis, VI 7-7704. 10cft

FOR RENT—Furnished house, Box 1737, Spanaway Loop Rd. 10c32

FOR RENT—1 or 2 2-bedroom modern, \$67.50 to \$77.50. Furnished or unfurnished. JU 8-8962. 10cft

Fuel (4)

KILN DRIED planer ends, small or large loads, Eichler Fuel. TH 5-2857. 4cft

HOUSEKEEPER for three, to live in, excellent conditions. Call LE 7-0515 days. 5cft

Help Wanted (5)

ATTENTION BARGAIN HUNTERS—I am selling this 1957 New Moon trailer, home at a ridiculously low price this week and this week only! Trailer has bedroom and a half, also bath and shower. It is heated by a Coleman oil circulator, cooking is by propane. You'll be amazed at the spacious freezing compartment. Full price \$1785.00, this week only. Call Wayne, days LE 7-0223. You can't afford to miss this. 8pft

BUSINESS SERVICES DIRECTORY

Floor Covering LINOLEUM, FORMICA, CARPETS FREE ESTIMATES PACIFIC FLOOR COVERING 131st & Pacific LE 7-4545	Moving - Storage Boush Moving & Storage Agents for U.S. Van Lines Cost to Coast Service 11816 Pacific Avenue LE 7-3696 Parkland, Wash.	Appliance Repair FRIGIDAIRE APPLIANCES New & Used No Down Payments Minimum Monthly Payments Maximum Trade-In Allowances McWik's JU 4-3300	Electric Contractor General Household Repairs & Installations VI 7-7137 WA 7-0704 Electric Co. ELECTRIC HEAT FREE ESTIMATES TH 5-0036	Auto Parts South End Auto Wreckers USED PARTS—Motors, Transmissions, Tires, Batteries. We buy junk cars. Also custom welding by Joe's Welding. 1 Mile East of Roy Y on Mt. Hy Spanaway VI 7-7242
Roof Repairs ROOF REPAIRS GUTTERS Cleaned & Repaired Gordon VI 7-7873	LET THIS SPACE WORK FOR YOU!	APPLIANCE REPAIRS All Makes Washers - Dryers - Ranges Dishwashers - Refrigerators HOME MAINTENANCE CO. 4804 E. 112th LE 1-2189	Septic Tank Serv. SEPTIC TANK CLEANING Prompt Service C. V. HUTSON GR 4-3980 GR 2-7038	Auto Repair McCALLUM'S AUTO REPAIR FOREIGN & DOMESTIC (Foreign Car Specialist) 112TH & CANYON ROAD Next to A&H Body Shop On Call After Hours LE 7-8890; Nites LE 7-0462
Cycle Shops PARKLAND CYCLE Mower Sharpening Complete Mower Service Complete Bike Service Rentals - Bike & Mower Duplicate Keys - Made While You Wait LE 7-5772 11021 Pacific Avenue	Don't Refinish Factory type furniture repairs in the home. Appliance and upholstery, too. Damage claim estimates made. RELIABLE FURNITURE SERVICE GR 4-8411	Chimney Service Logan Chimney Service Cleaning Furnace & Chimney, Repairs, New Chimneys. Very Reasonable - References 24-HOUR SERVICE GR 2-1511 8822 So. Park	Garden Supplies Shop G-R Compare our prices and quality. Perennials, Potted and Bedding Plants, Bulbs and Seeds. Aged Sawdust. Barnyard and Commercial Fertilizer. GARDEN-RITE 1211 E. 112th	Trash Removal Rural Garbage Service Pierce County Permit Serving Parkland, Midland, Summit and Spanaway LEnox 7-8688
Rock Hounds ROCK HOUNDS-STUDENTS! Economy Priced Rock Tumbler Polish Up To 10-Lbs. Rocks \$17.95 COMPLETE VAUGHAN'S LUMBER Pacific Avenue 84th & Pacific GR 4-9515	Cabinet Work KNAP LINE CUSTOM MADE CABINETS Complete Kitchen Remodeling Free Estimates Mill Work LE 7-5859	Rentals U & E RENTALS GRADER - DOZER - LOADER CHAIN SAW You Rent - or We Operate Road Building - Excavating Driveways Fill & Washed Material Call Canyon Gravel LE 7-3943	Prescriptions JACOBS PACIFIC DRUG PRESCRIPTION SERVICE 84th & Pacific Avenue GR 2-6445	Photo Studio PHOTOS 5x7, \$1 8x10, \$2 by Appointment, Phone GR 4-9840 FAMILY PORTRAIT STUDIO 8411 South Park Ave.

BOB'S FRIENDLY MARKET

HENRY HOUSE FRESH
SMOKED PICNICS 37¢
 Sliced - Tied 43c

Fresh Beltsville 6 to 8 Lb. Avg.
TURKEYS Lb. 49¢

Sliced Silver **SALMON** Lb. 59¢
 Ocean Fresh **HALIBUT** Lb. 69¢

Armour's Star Boneless 3-Lb. Fully Cooked **HAM** Pullman Style 2.89

Specially Made For Easter
Rope Sausage Lb. 69¢
EGGS AA Large Doz. 49¢

Ocean Spray **CRAN. SAUCE** 4/89¢
 Firm Ripe **BANANAS** Lb. 10¢
 Fancy Crisp **CELERY** Lb. 9¢
 Florida Red **NEW POTATOES** 3-Lbs. 23¢
 GREEN PEPPERS Lb. 19¢

Taylor's Canned **SWEET POTATOES** Reg. 33c Our Price 29¢
 Dari Sweet **ICE CREAM** 1/2 Gal. 59¢

Blue Bonnet **MARGARINE** 5/\$1
 Triple Pack **POTATO CHIPS** Reg. 49¢ 69c
 Langendorf **ANGEL CAKES** 3/\$1

Hours: 8:30 a.m. to 7:00 p.m.
 162nd & Park Ave. - Spanaway
 LE 7-8213 - Closed Sunday

Building Permits
 Building permit applications issued as of February 26, 1963:
 George P. Patrick, \$850 addn. to residence, 4323 E. 112th; Gary Allison, \$23,000 residence, 1129 122nd St. E.; Jay Millen, \$600 addn. to res., 4708 84th St.; Terry Hallie, \$2,000 residence, Enchanted Isle, Span. Lake; Geo. Barclay, \$14,600 res., 1401 Golden Given; Geo. Barclay, \$18,500 residence, 14208 Golden Given; Geo. Barclay, \$18,000 res., 14110 Golden Given; E. J. Rody & Sons, \$15,000 and \$16,000 ea. (2) residences, 8509 & 8515 60th Ave. E.; Harold W. Larson, \$14,000 residence, 11802 78th Ave. E.; Wm. D. Yotty, \$2419 addn. to residence, 5603 E. 103rd.

Legal Notices
 In the Superior Court of the State of Washington for the County of Pierce.
 IN PROBATE
 No. 71197
 NOTICE TO CREDITORS
 In the Matter of the Estate of INGA SOLAAS
 Deceased.
 Notice is hereby given that the undersigned has been appointed and has qualified as Executor of the estate of INGA SOLAAS, Deceased; that all persons having claims against said deceased are hereby required to serve the same, duly verified, on said Executor or his attorney, of record at the address below stated, and file the same together with proof of such service within six months after the date of first publication of this notice, or the same will be barred.
 Date of first publication April 11, 1963.
 NATIONAL BANK OF WASHINGTON
 By: s/John Hewitt Trust Officer
 Executor of said Estate
 11024 Pacific Ave., Tacoma 44, Wash.
 PETERS & TRACY
 Attorneys for Estate
 11024 Pacific Ave., Tacoma 44, Wash.
 Published in the Times Journal April 11, 18, 25, 1963.

State of Washington, Office of Supervisor of Water Resources, Olympia.
 NOTICE OF WATER RIGHT APPLICATION NO. 17800
 TAKE NOTICE:
 That MRS. LENORA WHEEL-OCK of Ashford, Washington on March 22, 1963 filed application for permit to divert the public waters of an unnamed spring area in the amount of 0.04 second-foot subject to existing rights, during irrigation season each year for the purpose of irrigation and continuously for sawmill, stock water and domestic supply; that the approximate point of diversion is located within SW 1/4 NE 1/4 of Section 25, Township 15 N., Range 6 E., W. M., in Pierce County.
 Any objections must be accompanied by a two dollar (\$2.00) recording fee and filed with the State Supervisor of Water Resources within thirty (30) days from April 11, 1963. Witness my hand and official seal this 26th day of March, 1963.
 M. G. WALKER,
 State Supervisor of Water Resources
 Published in the Times Journal April 4, 11, 1963.

FREE! Baby Chicks for Easter
 FIRST 500 CHILDREN ACCOMPANIED BY PARENTS WILL RECEIVE BABY CHICKS FREE!
 FRIDAY - SATURDAY ONLY - SPANAWAY
 G.I. Canvas Cots 3.95
 H. D. Tow Chains 2.95
 Desk 12.50
 Jeep Can Carriers 2.95
 Brand New **Camp Shovels 98c**
Sleeping Bags 5.95
 Army Blankets 2.98
 Inner Spring Matt. 7.50
 Surplus Bolt Cutters 4.95
 Field Jackets 1.29
 2 Burner Thermo Camp Stoves, new. 14.95

The BARGAIN BARN
 Two Locations: 1106 Market, Tac.; 17501 Pacific, Spanaway

USED Vacuum Cleaners as low as \$5. Airway bags, parts, repairs and hose for all makes of vacuum cleaners. Upton Electric, 1148 Market, FU 3-2551. Open Mon. and Fri. nites till 9. 15c32

SMITH-CORONA Portable Typewriter in good condition, new ribbon and has been cleaned recently. Call Yelm 458-7126. 15c32

RENT invalid and guest equipment. Upton Rental Inc., 4516 So. Tacoma Way, GR 2-3348. 15cft

ATTENTION HOUSEWIVES—POCHEL'S are now the authorized dealers for Speed Queen washers, automatic or wringer type, and dryers. Come in and see them at 140th and Pacific Ave., LE 7-8624. 15cft

FOR SALE—36x72 Chrome & formica extension table, 4 chairs, \$50; 8" Craftsman tilt arbor saw, delta gauge, motor, blades, dado set, \$65.00; Sunbeam electric razor, \$5. Electrolux vacuum cleaner, \$10. 1622 So. 106th. 15p32

FOR SALE—One female Black Labrador Retriever one year old. Has had shots. Contact Annette Williamson, 701 So. 113th, Tacoma, Wash. 15pft

GRAVEL, by the yard or load; also, complete tractor work. Yelm 458-7142. 15c34

UPTON SEZ
 Rent this Zenith 21" TV at \$10 each month and I will apply rental on purchase. Full price only \$89 with gar. All grades of military financed and desirable. Upton Electric, 1148 Market, FU 3-2551. Open Mon. and Fri. nites till 9. 15c32

EXPERIENCED MOTHER desires child care. Lots of love and play equipment; my home. 2822 E. 121st; phone LE 1-2593. 14pft

Miscellaneous 15
 ME. RICH???
 Yes, even you can afford this 21" RCA TV that was repossessed with only \$32 due. Assume \$10 monthly payments and we will be glad to finance any rank of military. Upton Electric, 1148 Market, FU 3-2551. Open Mon. and Fri. nites till 9. 15c32

FOR SALE—Siamese cat, female, two years old. LE 1-1809. 15p2ft

5 1/2 YARDS chicken or cow fertilizer, \$13.00 delivered; 5 1/2 yards top soil, \$8.00. LE 7-8760 or LE 7-4498. 15cft

FOR SALE—1963 GMC 3/4 PU, loaded, cost \$3500, 7500 miles, \$2550. Will take trade. Complete deluxe SCUBA outfit, cost \$450, excellent, \$225. Mens professional roller skates, 9 1/2 B, cost \$145, excellent, with case, \$75. Fisher X101 stereo amplifier, cost \$250, not working right, \$100. Mens ice hockey skates, size 10, like new, \$75.00. Sleeping bag, 3-lb. down, cost \$50, cheap, \$20. 2 Murphy beds, as is, \$6 ea. Sheffield silver and crystal decenter (4) set, circa 1820, \$295. TH 5-6938. 15p32

GRAVEL, fine or coarse, 5 1/2 yards, \$9.00. Washed sand, pea gravel, screened driveway mix, \$2.75 yard. Drain rock, beautiful quarry stone. Garden soil. Norman, any time, LE 7-4088. 15cft

USED RANGE, refrigerator, washer and dryer. Half-price. All working good, SK 2-3897. 15cft

FOR SALE—7-foot cedar posts. Can deliver. Eatonville 832-4808, Louis Elmh. 15p33

FOR SALE—140 gallon oil tank w/stand. Water tank free to buyer. LE 7-5717. 15c32

FOR SALE—Split cedar fence posts; also cedar 4x4 posts. VI 7-7423. 15c32

REFRIGERATORS from \$25 up; heavy crib, 4-ways, all good condition. LE 7-6089, evenings only or weekends. 15c32

WANT someone to take over ELECTROLUX—Only \$19 due at \$5 each month. Upton Electric, 1148 Market, FU 3-2551. Open Mon. and Fri. nites till 9. 15c32

HOOVER Canister Cleaner, repossessed with only \$19 due. Assume \$5 payments and save. Upton Electric, 1148 Market, FU 3-2551. Open Mon. and Fri. nites till 9. 15c32

DRIVEWAY GRAVEL—All sizes, 5 yards, \$8.00; complete tractor work. LE 7-3846. 15cft

OLD NEWSPAPERS—10-lb. bundle for 10c. Excellent for kindling, puppy training, etc. The Times Journal, 14620 Pacific Ave. 15pft

ALCOHOLICS Anonymous. Call LE 7-4813 or LE 7-7335. 15cft

POLAROID LAND CAMERA ACCESSORIES—Convert your old model Polaroid camera to a fully automatic model to use the new 3000 speed film. With Light attachment, plus a photo-electric shutter. (List price \$57.90) will go for only \$20.00. Call LE 7-0223. See at 14620 Pacific Ave. 15pft

State of Washington, Office of Supervisor of Water Resources, Olympia.
AMENDED NOTICE OF WATER RIGHT APPLICATION NO. 6615
TAKE NOTICE:
 That SPANAWAY WATER

Hope Lutheran Easter Services

Job's Daughters Spaghetti Feed Set For Apr. 17

Bethel No. 23 Job's Daughters will have a spaghetti

dinner April 17th at Fern Hill Masonic Temple, 84th and Park Ave. The dinner will be served from 5 to 6:45 p.m. and the public is invited. Donations of \$1 for adults, 75c for jobs and 50c for children under 12 will be asked.

Easter Shoes

Ladies Patent Flats, Black, Red, White. . . . \$4.99 and \$5.95
 Child's Patents, Reg. to 4-00. 5 to 8, 8 1/2 to 3. . . . \$2.99
 Children's White and Beiges \$2.99
 Womens Dress Heels, tint to match satins. 2.99!
 Reg. to 13.00.
 Womens Patents. \$5.95 and \$6.95
 Boys Dress Oxfords. \$4.99 to \$7.95
 Little Boys Oxfords. \$2.99 to \$5.95
 Mens Dress Oxfords. \$5.95 to \$11.95
 Mens Rebuilt Oxfords \$2.99

PAUL'S SHOES

Open Monday thru Saturday 9 to 6 — Fridays Till 9 p.m.
 161st & Pacific Ave., Spanaway (Closed Sundays) LE 7-0552

69¢ Lb. Round Steak	59¢ Lb. Rump Roast	69¢ Lb. Sirloin Steak	79¢ Lb. Porterhouse	69¢ Lb. Rib Steak	Our Own Country Style PORK Sausage 3 Lbs. \$1
<h2>25 LB. Locker Box</h2> <p>7 1/2 Lbs. ROAST 7 1/2 Lbs. STEAK 7 1/2 Lbs. GR. BEEF 2 1/2 Lbs. Short Ribs</p>					

69¢ Lb. Flank Steak	79¢ Lb. Beef Stew Boneless	98¢ 3 Lbs. Ground Beef	79¢ Lb. T-Bone Steak	49¢ Lb. Short Ribs	\$12.95

Easter HAM Carstens Fully Cooked Ready To Eat. Lb. 79¢ CARSTENS Tenderized Whole 12-16 Lb. Avg. Lb. 49¢	Bar-S Thrifty Sliced Bacon Lb. 39¢	Boneless Fillet RED SNAPPER Lb. 39¢
---	---	---

Pine Isle Sliced Pineapple No. 2 Tin 5/\$1	Asst. Flavors JELLO Pkg. 5¢
Libby's Fruit Cocktail Large 2 1/2 Tin 27¢	Josty Pack PEAS 303 Tiny, No. 1 Sieve Case of 24 \$2-95 7/\$1

Sugary Sam YAMS 303 Tin 2/35¢	Ocean Spray Cranberry Sauce Whole 16-Oz. Or Jellied 2/39¢	Sunny Jim MUSTARD 16-Oz. Jar 2/29	Kellogg's 12-Oz. Pkg. CORN FLAKES 4/\$1	Bakers PREMIUM SHREDDED ANGEL FLAKE 3 \$1
Curtis Marshmallows EASTER EGGS 10oz Pkg. 19¢	GARDEN FRESH No. 1 Fancy Sweet Potatoes 2 Lbs. 25¢	No. 1 Wash. Cello Bag POTATOES 10-Lbs. 29¢	Fine For Stuffing GR. PEPPERS EA. 5¢	Crisp Stalks CELERY EA. 10¢

9 a.m. to 10 p.m. 7 DAYS WEEK

BARGAIN BASKET

16618 PACIFIC AVE. South SPANAWAY, WASH.

COAL • PRES-TO-LOGS • LE 7-3371 •

NO SALE TO DEALERS

OPEN EASTER SUNDAY 9 a.m. to 10 p.m.

Prices Effective Thurs.-Fri.-Sat. April 11-12-13

We Reserve The Right To Limit Quantities

Work Camp Is Planned By Spanaway Teens

Mrs. Louis Symmons LE 1-1425

On Easter Sunday the Spanaway Methodist Church will conduct special services with new members joining, and baptismal services being held at the regular time.

Youth Activities

The Sand Point Methodist Fellowship Work Camp will be guests at the Spanaway Methodist Church this week, having a Kidnap Party on Tuesday, a splash party on Wednesday, and on Thursday evening a Communion Service which will be open to everyone.

Spanaway P-TA

The Spanaway P-TA will hold their monthly meeting on Tuesday, April 16th at 8 p.m. There will be election of officers, and a delegate to the Convention in Bellingham will be chosen.

Our Princess Karen

We are very proud of our Princess Karen Iverson. She and the other Princesses and everyone who walked in the rain at the Daffodil Parade had a great deal of courage. We also have to commend the Boosters Club and all the other people who designed and made the float, entitled "Great Moments of Jazz", and won first place in Division Four.

Sergeant Recovers

Very glad to hear MSGT. Troupe is recuperating, and hopes to be home from the hospital for Easter.

On The Mend

Mrs. Don McLellan came home from the hospital last

Canyon Rd. Garden Club Plans Events

Mrs. John Folk LE 7-5801

The regular meeting of the Canyon Road Community Club will be held Thursday, April 11th (tonight) at 8 p.m. All residents of this community are cordially welcome.

Garden News

The Canyon Road Garden Club will hold their regular meeting Wednesday, April 17 at 7:30 in the newly painted community hall, proceeds of the bake sale held by the Garden Club Ladies, who also did the painting. Roll call will be "Spring Flowers I Have in Bloom". Mrs. Dorothy McPherson will give a talk on hanging baskets and plants. Pauline Fanning and Victoria Davidek will present a program on grooming plants and flowers for show and arranging and understanding schedules. Hostesses for the evening will be the Mesdames Merna Dickson and Rose Cook. We wish to congratulate the Mesdames Everett Peake, Frank Susan and Jerry Rowe on receiving Blue Ribbons at the Puyallup Flower Show and Mrs. Leo Fanning for her second and third prize. All were entered under Canyon Road Garden Club.

Dinner Planned

The Canyon Road Ladies Auxiliary will hold their meeting April 18 after a 12:00 luncheon with the Mesdames Pat Hoffman, Myrt Judy, Margaret Richter and Barbara Cortes as hostesses. Final plans will be made for the Sunday dinner which will be held at the hall April 21st from 12 noon until 5 p.m. Adults \$1.50, Children under 12, 75c. Proceeds to pay off our new floor.

Dance Postponed

We have been asked to postpone our Teen Dance from April 19 to April 26 because of the Easter holidays and the Sunday dinner. This will be an Old Clothes Dance, so come in your finest rags and the donation will be 25c. Curly Campbell will be your M. C.

Returnees

We will soon be welcoming "old, new" neighbors on Fairview Road. Mr. and Mrs. Gary Rogers (Margoty) who have been residents of East 72nd for a number of years are building a new home on Fairview Road and will be living next door to Gary's brother and sister-in-law, Mr. and Mrs. Richard Rogers (Sharon).

Thank You

Mr. and Mrs. John Folk of Canyon Road, wish to thank everyone for their sympathy notes on the passing of Mrs. Folk's aunt, Mrs. Kathryn Bartlett of Portland, who had been ill for a number of years.

Emergency Surgery

Mr. Ray Lester of Canyon Road, who was just about to be released from the hospital after undergoing major surgery, had an emergency operation Saturday night but is reported feeling much better. Let us hope he will be home soon.

Pleasure Rides Popular With 4-H

The pleasure riding light horse business is really growing here as well as all over the United States. In our county the number of 4-H horse project members last year jumped from 62 to 138 and the number continues to grow. We have a growing number of local horse trainers, horseshoers, boarding stables and various other enterprises related to horses. Horses financially support many of the big and small fairs in our state. This occurs from the apportionment of pari-mutuel race horse bet taxes from Longacres.

Letters To The Editor:

Mister Brown!

The first thing I do when THE TIMES JOURNAL arrives is to turn to A-Wondering and A-Wandering.

I'm a-wondering what you think of this idea? You have a special gift of spontaneous humor so why not have a fun column on page ONE? Then, if you must be serious, and I know you must, continue with your original column on page two?

You read so many things, that pass as humor and you make with a weak smile, but how many times can you have a good laugh? Like when you bent over to try to retrieve your press button during a heavy rain storm in Canada? Then I liked the one about the Tacoma escalator, etc. etc. We moved to Eatonville from Sunnyside, Wash. in September and love it.

I noticed this quotation in the April 4 issue. "Ah, children, you are the bulwarks of freedom, the cement of society, the hope of our race." The source was not given so I looked it up in my Concordance and found it in Pulpit & Press, page 9, line 2 — by Mary Baker Eddy.

Sincerely,
 Marion Hilligoss
 (Mrs. W. C.)

AT LAST IN SPANAWAY

Live Jazz

BY Peter Gruenstein

AT THE THREE MONKEYS SUPPER CLUB

- NIGHTLY - (CLOSED MONDAYS)

161st & Pacific Avenue LE 7-0515

SEYMOUR'S

Women's Canvas CASUALS

Sizes 5 to 10

Special! **1.99**

Smart canvas slippers in blue, black or red. Tie styles in assorted colors and white.

Shop Daily 9 a.m. to 9 p.m. Sundays, 10 to 6 p.m.

SEYMOUR'S

9714 PACIFIC AVENUE Free Front Door Parking

SERVICE UP... for Spring

We Carefully Check As Many As 75 Places On Your Car During Our Supervised Lubrications

Even The Newest Cars Require Periodic Service . . .

- TUNE-UP
- COOLING SYSTEM
- BRAKES
- HEADLIGHTS
- TRANSMISSION
- TIRES

GAS and OIL at COMPETITIVE PRICES

BOB'S PLACE

Serving The Parkland Area For Over 27 Years Continuously.

112th (Airport Road) & Jay Street LE 7-3395